

FXW Series, 1000 Watt

DC/DC Converters



The 4:1 Input Voltage 1000 Watt Single FXW DC/DC converter provides a precisely regulated dc output. The output voltage is fully isolated from the input, allowing the output to be positive or negative polarity and with various ground connections. The 1000 Watt FXW meets the most rigorous performance standards in an industry standard footprint for mobile (12Vin), process control (24Vin), and military COTS (28Vin) applications.

The 4:1 Input Voltage 1000W FXW includes trim and remote ON/OFF. Threaded through holes are provided to allow easy mounting or addition of a heatsink for extended temperature operation.

The converters high efficiency and high power density are accomplished through use of high-efficiency synchronous rectification technology, advanced electronic circuit, packaging and thermal design thus resulting in a high reliability product. Converter operates at a fixed frequency and follows conservative component de-rating guidelines.

Features

- 4:1 Input voltage range
- High power density
- Small size 2.5" x 4.7" x 0.52"
- Efficiency up to 96%
- Excellent thermal performance with metal baseplate
- Over-Current and Short Circuit Protection
- Over-Temperature protection
- Auto-restart
- Monotonic startup into pre bias
- Constant frequency
- Remote ON/OFF
- Good shock and vibration damping
- Temperature Range -40°C to +105°C Available.
- RoHS Compliant
- UL60950 Approved

Table of Contents

Part Number Selection Table & Description	2	Characteristic Curves	16
Electrical Specifications	3	Characteristic Waveforms	20
Operations	10	EMC Consideration	25
Test Configuration	15	Mechanical Specification	26

Part Number Selection Table

Voltage (VDC)		Current				Efficiency	Ripple & Noise	Regulation	Capacitive Load	Root Model
Input	Output	Input	Output							
Vin Nom	Vin Range	Vout Nom	No Load (mA)	Max Load (A)	Io Max (A)	Typical at Max Load (%)	Typical (mVp-p)	Line / Load Max (%)	Max. C external (µF)	Basic Model without option
24	9 – 36	12	.55	92	84	93	120	.05/.05	4700	24S12.84FXW
		24	.42	92	42	94.6	200	.05/.05	4700	24S24.42FXW
		28	.55	92	36	95.5	220	.05/.05	4700	24S28.36FXW
		48	.47	92	21	95	100	.05/.05	3000	24S48.21FXW
		53	.46	92	19	95	70	.05/.05	2200	24S53.19FXW

1. Negative Logic ON/OFF feature available. Add “-N” to the part number when ordering. i.e. 24S24.42FXW-N (ROHS)
2. Designed to meet MIL-STD-810G for functional shock and vibration. The unit must be properly secured to the interface medium (PCB/Chassis) by use of the threaded inserts of the unit.
3. A thermal management device, such as a heatsink, is required to ensure proper operation of this device. The thermal management medium is required to maintain baseplate < 105°C for full rated power.
4. Non-Standard output voltages are available. Please contact the factory for additional information.

Part Number Description

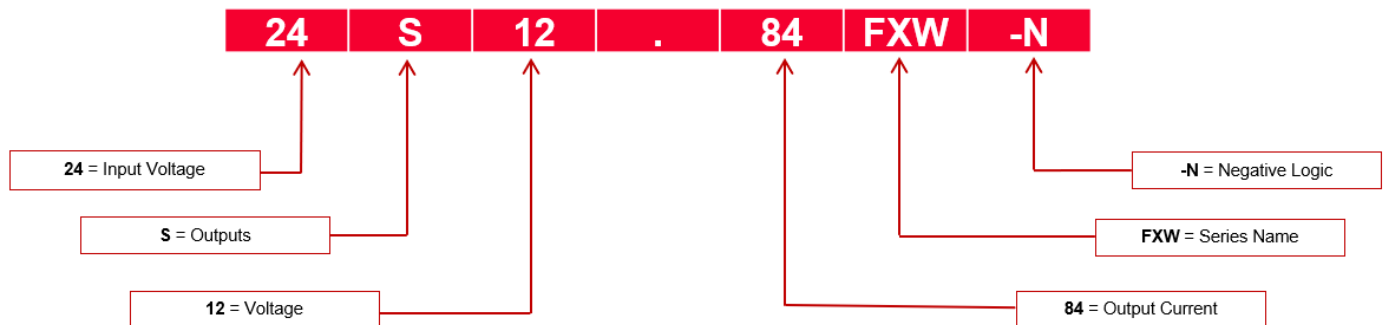



FXW Series, 1000 Watt

DC/DC Converters

Electrical Specifications

Conditions: $T_A = 25\text{ }^\circ\text{C}$, Airflow = 300 LFM (1.5 m/s), $V_{in} = 24\text{VDC}$, unless otherwise specified. Specifications are subject to change without notice.

All Models					
Parameter	Notes	Min	Typ	Max	Units
Absolute Maximum Ratings					
Input Voltage	Continuous	0		40	V
	Transient (100ms)			50	V
Operating Temperature	Baseplate (100% load)	-40		105	$^\circ\text{C}$
Storage Temperature		-55		125	$^\circ\text{C}$
Isolation Characteristics and Safety					
Isolation Voltage	Input to Output	2250			V
	Input to Baseplate & Output to Baseplate	1500			V
Isolation Capacitance			9000		pF
Isolation Resistance		10	20		M Ω
Insulation Safety Rating			Basic		
Designed to meet UL/cUL 60950, IEC/EN 60950-1					
Feature Characteristics					
Fixed Switching Frequency			200		kHz
	Input Current and Output Voltage Ripple		400		kHz
Output Voltage Trim Range	Adjustable via TRIM (Pin 12)	60		110	%
Remote Sense Compensation	Between SENSE+ and +OUT pins			1	V
Output Overvoltage Protection	Non-latching	114	122	130	%
Overtemperature Shutdown (Baseplate)	Non-latching ($V_{in}=9\text{V}; 12\text{V}, 24/36\text{V}$)	108	112	115	$^\circ\text{C}$
Auto-Restart Period	Applies to all protection features	1.7	2	2.3	s
Turn-On Delay Time from V_{in}	Time from UVLO to $V_o=90\%V_{OUT}$ (NOM) Resistive load	480	517	530	ms
Turn-On Delay Time from ON/OFF Control (From ON to 90% V_{OUT} (NOM) Resistive load)	24S24.42FXW & 24S28.36FXW	20	27	35	ms
	24S48.21FXW & 24S53.19FXW	20	35	50	ms
Rise Time (V_{out} from 10% to 90%)	24S24.42FXW & 24S28.36FXW	4	7	11	ms
	24S48.21FXW & 24S53.19FXW	7	15	25	ms
ON/OFF Control – Positive Logic					
ON state	Pin open = ON or	2		12	V
Control Current	Leakage current			0.16	mA
OFF state		0		0.8	V
Control current	Sinking	0.3		0.36	mA
ON/OFF Control – Negative Logic					
ON state	Pin shorted to – ON/OFF pin or	0		0.8	V
OFF state	Pin open = OFF or	2		12	V
Thermal Characteristics					
Thermal resistance Baseplate to Ambient	Converter soldered to 5" x 3.5" x 0.07", 4 layers/ 2Oz copper FR4 PCB.		3.3		$^\circ\text{C}/\text{W}$



FXW Series, 1000 Watt

DC/DC Converters

Electrical Specifications (Continued):

Conditions: $T_A = 25\text{ }^\circ\text{C}$, Airflow = 300 LFM (1.5 m/s) and 0.9" heatsink, $V_{in} = 14\text{VDC}$, unless otherwise specified. Specifications are subject to change without notice.

24S12.84FXW					
Parameter	Notes	Min	Typ	Max	Units
Input Characteristics					
Operating Input Voltage Range		9	14	36	V
Input Under Voltage Lockout	Non-latching				
Turn-on Threshold		8.2	8.5	8.8	V
Turn-off Threshold		7.7	8.0	8.3	V
Lockout Hysteresis Voltage		0.4	0.55	0.7	V
Maximum Input Current	$V_{in} = 9\text{V}$, 80% Load			89	A
	$V_{in} = 12\text{V}$, 100% Load			92	A
	$V_{in} = 14\text{V}$, Output Shorted		600		mA_{RMS}
Input Stand-by Current	Converter Disabled		2	4	mA
Input Current @ No Load	Converter Enabled	450	550	690	mA
Minimum Input Capacitance (external) ¹	See Table 1	1000			μF
Inrush Transient				0.19	A^2s
Input Terminal Ripple Current, i_c	25 MHz bandwidth, 100% Load (Fig. 2)		3.65		A_{RMS}
Output Characteristics					
Output Voltage Range		11.64	12.00	12.36	V
Output Voltage Set Point Accuracy	(No load)	11.90	12.00	12.10	V
Output Regulation					
Over Line	$V_{in} = 9\text{V}$ to 36V		0.05	0.10	%
Over Load	$V_{in} = 14\text{V}$, Load 0% to 100%		0.05	0.150	%
Temperature Coefficient			0.005	0.015	$\text{\%/}^\circ\text{C}$
Overvoltage Protection		14		15.6	V
Output Ripple and Noise – 20 MHz bandwidth	100% Load, See Table 1 for external components		120		$\text{mV}_{\text{PK-PK}}$
			40		mV_{RMS}
External Load Capacitance 1)	See Table 1				
Output Current Range (See Fig. A)	$V_{in} = 12\text{V} - 36\text{V}$	0		84	A
	$V_{in} = 9\text{V}$	0		67.2	A
Current Limit Inception	$V_{in} = 12\text{V} - 36\text{V}$	92.4	100.8	109.2	A
	$9\text{V} \leq V_{in} < 12\text{V}$	73.5		109.2	A
RMS Short-Circuit Current	Non-latching, Continuous		7		A_{RMS}
Dynamic Response					
Load Change 50%-100%-50%, $di/dt = 0.5\text{A}/\mu\text{s}$	See Table 1 for external capacitors		± 500		mV
Settling Time to 1% of V_{OUT}			800		μs
Efficiency					
100% Load	$V_{in} = 14\text{V}$		93.0		%
	$V_{in} = 12\text{V}$		92.3		%
50% Load	$V_{in} = 14\text{V}$		95.4		%
	$V_{in} = 12\text{V}$		95.0		%

1) Section "Input and Output Capacitance"



FXW Series, 1000 Watt

DC/DC Converters

Electrical Specifications (Continued):

Conditions: $T_A = 25\text{ }^\circ\text{C}$, Airflow = 300 LFM (1.5 m/s), $V_{in} = 24\text{VDC}$, unless otherwise specified. Specifications are subject to change without notice.

24S24.42FXW						
Parameter	Notes	Min	Typ	Max	Units	
Input Characteristics						
Operating Input Voltage Range		9	24	36	V	
Input Under Voltage Lockout	Non-latching					
Turn-on Threshold		8.2	8.5	8.8	V	
Turn-off Threshold		7.7	8.0	8.3	V	
Lockout Hysteresis Voltage		0.4	0.55	0.7	V	
Maximum Input Current	$V_{in} = 9\text{V}$, 80% Load			89	A	
	$V_{in} = 12\text{V}$, 100% Load			92	A	
	$V_{in} = 24\text{V}$, Output Shorted		350		mA_{RMS}	
Input Stand-by Current	Converter Disabled		2	4	mA	
Input Current @ No Load	Converter Enabled	330	420	530	mA	
Minimum Input Capacitance (external) ¹	ESR < 0.1 Ω	1000			μF	
Inrush Transient				0.19	A^2s	
Input Terminal Ripple Current, i_c	25 MHz bandwidth, 100% Load (Fig. 5)		3.65		A_{RMS}	
Output Characteristics						
Output Voltage Range		23.62	24.00	24.36	V	
Output Voltage Set Point Accuracy	(No load)	23.90	24.00	24.10	V	
Output Regulation						
Over Line	$V_{in} = 9\text{V}$ to 36V		0.05	0.10	%	
Over Load	$V_{in} = 24\text{V}$, Load 0% to 100%		0.05	0.10	%	
Temperature Coefficient			0.005	0.015	$\text{\%/}^\circ\text{C}$	
Overvoltage Protection		27.36		31.2	V	
Output Ripple and Noise – 20 MHz bandwidth	100% Load, See Table 1 for external components		200	320	$\text{mV}_{\text{PK-PK}}$	
			50	80	mV_{RMS}	
External Load Capacitance ¹	Full Load (resistive) (over operating temp range)	C_{EXT}	1000		4700	μF
		ESR	10		100	$\text{m}\Omega$
Output Current Range (See Fig. A)	$V_{in} = 12\text{V} - 36\text{V}$	0		42	A	
	$V_{in} = 9\text{V}$	0		33.5	A	
Current Limit Inception	$V_{in} = 12\text{V} - 36\text{V}$	46	50.2	54.6	A	
	$9\text{V} \leq V_{in} < 12\text{V}$	37	49	54.6	A	
RMS Short-Circuit Current	Non-latching, Continuous	2.0	3.1	6.5	A_{RMS}	
Dynamic Response						
Load Change 50%-75%-50%, $di/dt = 1\text{A}/\mu\text{s}$	$C_o = 2 \times 470\text{ }\mu\text{F}/70\text{m}\Omega$		± 400	± 600	mV	
Load Change 50%-100%-50%, $di/dt = 1\text{A}/\mu\text{s}$	$C_o = 2 \times 470\text{ }\mu\text{F}/70\text{m}\Omega$		± 700		mV	
Settling Time to 1% of V_{OUT}			500		μs	
Efficiency						
100% Load	$V_{in} = 24\text{V}$	93.6	94.6	95.3	%	
	$V_{in} = 12\text{V}$	92.4	93.4	94	%	
50% Load	$V_{in} = 24\text{V}$	95.0	96	96.4	%	
	$V_{in} = 12\text{V}$	94.7	95.7	96.3	%	

1) Section "Input and Output Capacitance"



FXW Series, 1000 Watt

DC/DC Converters

Electrical Specifications (Continued):

Conditions: $T_A = 25\text{ }^\circ\text{C}$, Airflow = 300 LFM (1.5 m/s), $V_{in} = 24\text{VDC}$, unless otherwise specified. Specifications are subject to change without notice.

24S28.36FXW						
Parameter	Notes	Min	Typ	Max	Units	
Input Characteristics						
Operating Input Voltage Range		9	24	36	V	
Input Under Voltage Lockout	Non-latching					
Turn-on Threshold		8.2	8.5	8.8	V	
Turn-off Threshold		7.7	8.0	8.3	V	
Lockout Hysteresis Voltage		0.4	0.55	0.7	V	
Maximum Input Current	$V_{in} = 9\text{V}$, 80% Load			89	A	
	$V_{in} = 12\text{V}$, 100% Load			92	A	
	$V_{in} = 24\text{V}$, Output Shorted		350		mA_{RMS}	
Input Stand-by Current	Converter Disabled		2	4	mA	
Input Current @ No Load	Converter Enabled	400	480	600	mA	
Minimum Input Capacitance (external) ¹	ESR < 0.1 Ω	1000			μF	
Inrush Transient				0.19	A^2s	
Input Terminal Ripple Current, i_c	25 MHz bandwidth, 100% Load (Fig. 6)		2.5		A_{RMS}	
Output Characteristics						
Output Voltage Range		27.56	28.00	28.42	V	
Output Voltage Set Point Accuracy	(No load)	27.9	28.00	28.10	V	
Output Regulation						
Over Line	$V_{in} = 9\text{V}$ to 36V		0.05	0.10	%	
Over Load	$V_{in} = 24\text{V}$, Load 0% to 100%		0.05	0.10	%	
Temperature Coefficient			0.005	0.015	$\text{\%/}^\circ\text{C}$	
Overshoot Protection		31.90		36.4	V	
Output Ripple and Noise – 20 MHz bandwidth	100% Load, See Table 1 for external components		220	360	$\text{mV}_{\text{PK-PK}}$	
			50	80	mV_{RMS}	
External Load Capacitance ¹	Full Load (resistive) (over operating temp range)	C_{EXT}	1000		4700	μF
		ESR	10		100	$\text{m}\Omega$
Output Current Range (See Fig. A)	$V_{in} = 12\text{V} - 36\text{V}$	0		36	A	
	$V_{in} = 9\text{V}$	0		28.8	A	
Current Limit Inception	$V_{in} = 12\text{V} - 36\text{V}$	39.6		46.8	A	
	$9\text{V} \leq V_{in} < 12\text{V}$	31.7		46.8	A	
RMS Short-Circuit Current	Non-latching, Continuous	1.7	2.5	6.4	A_{RMS}	
Dynamic Response						
Load Change 50%-75%-50%, $di/dt = 1\text{A}/\mu\text{s}$	See Table 1 for external components		± 330	± 430	mV	
Load Change 50%-100%-50%, $di/dt = 1\text{A}/\mu\text{s}$	See Table 1 for external components		± 600		mV	
Settling Time to 1% of V_{OUT}			500		μs	
Efficiency						
100% Load	$V_{in} = 24\text{V}$	94.5	95.5	96.2	%	
	$V_{in} = 12\text{V}$	93.0	93.8	94.5	%	
50% Load	$V_{in} = 24\text{V}$	95.5	96.2	97	%	
	$V_{in} = 12\text{V}$	94.3	95.4	96.2	%	

1) Section "Input and Output Capacitance"



FXW Series, 1000 Watt

DC/DC Converters

Electrical Specifications (Continued):

Conditions: $T_A = 25\text{ }^\circ\text{C}$, Airflow = 300 LFM (1.5 m/s), $V_{in} = 24\text{VDC}$, unless otherwise specified. Specifications are subject to change without notice.

24S48.21FXW						
Parameter	Notes	Min	Typ	Max	Units	
Input Characteristics						
Operating Input Voltage Range		9	24	36	V	
Input Under Voltage Lockout	Non-latching					
Turn-on Threshold		8.2	8.5	8.8	V	
Turn-off Threshold		7.7	8.0	8.3	V	
Lockout Hysteresis Voltage		0.4	0.55	0.7	V	
Maximum Input Current	$V_{in} = 9\text{V}$, 80% Load			89	A	
	$V_{in} = 12\text{V}$, 100% Load			92	A	
	$V_{in} = 24\text{V}$, Output Shorted		400		mA_{RMS}	
Input Stand-by Current	Converter Disabled		2	4	mA	
Input Current @ No Load	Converter Enabled	370	470	560	mA	
Minimum Input Capacitance (external) ¹	ESR < 0.1 Ω	1000			μF	
Inrush Transient				0.19	A^2s	
Input Terminal Ripple Current, i_c	25 MHz bandwidth, 100% Load (Fig. 6)		0.9		A_{RMS}	
Output Characteristics						
Output Voltage Range		47.28	48.00	48.92	V	
Output Voltage Set Point Accuracy	(No load)	47.80	48.00	48.20	V	
Output Regulation						
Over Line	$V_{in} = 9\text{V}$ to 36V		0.05	0.10	%	
Over Load	$V_{in} = 24\text{V}$, Load 0% to 100%		0.05	0.10	%	
Temperature Coefficient			0.005	0.015	$\text{\%/}^\circ\text{C}$	
Overvoltage Protection		54.7		62.4	V	
Output Ripple and Noise – 20 MHz bandwidth	100% Load, See Table 1 for external components		100	150	$\text{mV}_{\text{PK-PK}}$	
			25	50	mV_{RMS}	
External Load Capacitance ¹	Full Load (resistive) (over operating temp range)	C_{EXT}	470		3000	μF
		ESR	10		100	m Ω
Output Current Range (See Fig. A)	$V_{in} = 12\text{V} - 36\text{V}$	0		21	A	
	$V_{in} = 9\text{V}$	0		16.8	A	
Current Limit Inception	$V_{in} = 12\text{V} - 36\text{V}$	23.1	25.2	27.3	A	
	$9\text{V} \leq V_{in} < 12\text{V}$	18.48	20.16	27.3	A	
RMS Short-Circuit Current	Non-latching, Continuous	1.0	1.6	3.3	A_{RMS}	
Dynamic Response						
Load Change 50%-75%-50%, $di/dt = 1\text{A}/\mu\text{s}$	See Table 1 for external components		± 480	± 560	mV	
Load Change 50%-100%-50%, $di/dt = 1\text{A}/\mu\text{s}$	See Table 1 for external components		± 880	± 1150	mV	
Settling Time to 1% of V_{OUT}			500		μs	
Efficiency						
100% Load	$V_{in} = 24\text{V}$	94.3	95.0	95.7	%	
	$V_{in} = 12\text{V}$	93.2	93.9	94.6	%	
50% Load	$V_{in} = 24\text{V}$	95.3	96	96.7	%	
	$V_{in} = 12\text{V}$	94.9	95.6	96.3	%	

1) Section "Input and Output Capacitance"



FXW Series, 1000 Watt

DC/DC Converters

Electrical Specifications (Continued):

Conditions: $T_A = 25\text{ }^\circ\text{C}$, Airflow = 300 LFM (1.5 m/s), $V_{in} = 24\text{VDC}$, unless otherwise specified. Specifications are subject to change without notice.

24S53.19FXW						
Parameter	Notes	Min	Typ	Max	Units	
Input Characteristics						
Operating Input Voltage Range		9	24	36	V	
Input Under Voltage Lockout	Non-latching					
Turn-on Threshold		8.2	8.5	8.8	V	
Turn-off Threshold		7.7	8.0	8.3	V	
Lockout Hysteresis Voltage		0.4	0.55	0.7	V	
Maximum Input Current	$V_{in} = 9\text{V}$, 80% Load			89	A	
	$V_{in} = 12\text{V}$, 100% Load			92	A	
	$V_{in} = 24\text{V}$, Output Shorted		300		mA _{RMS}	
Input Stand-by Current	Converter Disabled		2	4	mA	
Input Current @ No Load	Converter Enabled	360	460	560	mA	
Minimum Input Capacitance (external) ¹	ESR < 0.1 Ω	1000			μF	
Inrush Transient				0.19	A ² s	
Input Terminal Ripple Current, i_c	25 MHz bandwidth, 100% Load (Fig. 6)		0.8		A _{RMS}	
Output Characteristics						
Output Voltage Range		52.20	53.00	54.02	V	
Output Voltage Set Point Accuracy	(No load)	52.78	53.00	53.22	V	
Output Regulation						
Over Line	$V_{in} = 9\text{V}$ to 36V		0.05	0.10	%	
Over Load	$V_{in} = 24\text{V}$, Load 0% to 100%		0.05	0.10	%	
Temperature Coefficient			0.005	0.015	%/°C	
Overvoltage Protection		60.4	64.7	69.4	V	
Output Ripple and Noise – 20 MHz bandwidth	100% Load, See Table 1 for external components		70	140	mV _{PK-PK}	
			16	50	mV _{RMS}	
External Load Capacitance ¹	Full Load (resistive) (over operating temp range)	C_{EXT}	470		2200	μF
		ESR	10		100	m Ω
Output Current Range (See Fig. A)	$V_{in} = 12\text{V} - 36\text{V}$	0		19	A	
	$V_{in} = 9\text{V}$	0		15.2	A	
Current Limit Inception	$V_{in} = 12\text{V} - 36\text{V}$	20.9	22.8	24.7	A	
	$9\text{V} \leq V_{in} < 12\text{V}$	16.7	18.2	24.7	A	
RMS Short-Circuit Current	Non-latching, Continuous	0.8	1.8	3.0	A _{RMS}	
Dynamic Response						
Load Change 50%-75%-50%, $di/dt = 1\text{A}/\mu\text{s}$	See Table 1 for external components		± 420	± 510	mV	
Load Change 50%-100%-50%, $di/dt = 1\text{A}/\mu\text{s}$	See Table 1 for external components		± 850	± 1100	mV	
Settling Time to 1% of V_{OUT}			500		μs	
Efficiency						
100% Load	$V_{in} = 24\text{V}$	94.9	95.7	96.4	%	
	$V_{in} = 12\text{V}$	93.4	94.1	95	%	
50% Load	$V_{in} = 24\text{V}$	95.3	96.2	96.9	%	
	$V_{in} = 12\text{V}$	95.1	95.4	96.5	%	

1) Section "Input and Output Capacitance"



FXW Series, 1000 Watt

DC/DC Converters

Environmental and Mechanical Specifications. Specifications are subject to change without notice.

Parameter	Note	Min	Typ	Max	Units
Environmental					
Operating Humidity	Non-condensing			95	%
Storage Humidity	Non-condensing			95	%
ROHS Compliance ¹	See Calex Website http://www.calex.com/RoHS.html for the complete RoHS Compliance statement				
Shock and Vibration	Designed to meet MIL-STD-810G for functional shock and vibration.				
Water washability	Not recommended for water wash process. Contact the factory for more information.				
Mechanical					
Weight			8.55		Ounces
			242		Grams
Through Hole Pins Diameter	Pins 3, 3A, 4, 4A, 5, 6, 8 and 9	0.079	0.081	0.083	Inches
		2.006	2.057	2.108	mm
	Pins 1, 2, 10, 11 and 12	0.038	0.04	0.042	Inches
		0.965	1.016	1.067	mm
Through Hole Pins Material	Pins 3, 3A, 4, 4A, 5, 6, 8 and 9	14500 or C1100 Copper Alloy			
	Pins 1, 2, 10, 11 and 12	TB3 or "Eco Brass"			
Through Hole Pin Finish	All pins	10µ" Gold over nickel			
Case Dimension		4.7 x 2.5 x 0.52			Inches
		119.38 x 63.50 x 13.21			mm
Case Material	Plastic: Vectra LCP FIT30: ½-16 EDM Finish Plastic				
Baseplate	Material	Aluminum			
	Flatness		0.010		Inches
			0.25		mm
Reliability					
MTBF	Telcordia SR-332, Method I Case 1 50% electrical stress, 40°C components		5.4		MHrs
Agency Approvals	UL60950 Approved				
EMI and Regulatory Compliance					
Conducted Emissions	MIL-STD 461F CE102 with external EMI filter network (See Figs. 57 and 58)				

Additional Notes:

1 The RoHS marking is as follows 

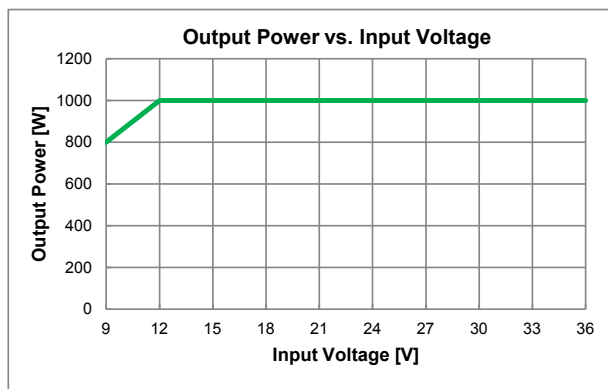

Figure A: Output Power as function of input voltage.



FXW Series, 1000 Watt

DC/DC Converters

Operations

Input Fusing

The FXW converters do not provide internal fusing and therefore in some applications external input fuse may be required. Use of external fuse is also recommended if there is possibility for input voltage reversal. For greatest safety, it is recommended to use fast blow fuse in the ungrounded input supply line.

Input Reverse Polarity Protection

The FXW converters do not have input reverse polarity. If input voltage polarity is reversed, internal diodes will become forward biased and draw excessive current from the power source. If the power source is not current limited or input fuse not used, the converter could be permanently damaged.

Input Undervoltage Protection

Input undervoltage lockout is standard with this converter. The FXW converter will start and regulate properly if the ramping-up input voltage exceeds Turn-on threshold of typ. 8.5V (See Specification) and remains at or above Turn-on Threshold.

The converter will turn off when the input voltage drops below the Turn-off Threshold of typical 8V (See specification) and converter enters hiccup mode and will stay off for 2 seconds. The converter will restart after 2 seconds only if the input voltage is again above the Turn-on Threshold.

The built-on hysteresis and 2 second hiccup time prevents any unstable on/off operation at the low input voltage near Turn-on Threshold.

User should take into account for IR and inductive voltage drop in the input source and input power lines and make sure that the input voltage to the converter is always above the Turn-off Threshold voltage under ALL OPERATING CONDITIONS.

Start-Up Time

The start-up time is specified under two different scenarios: a) Startup by ON/OFF remote control (with the input voltage above the Turn-on Threshold voltage) and b) Start-up by applying the input voltage (with the converter enabled via ON/OFF remote control).

The startup times are measured with maximum resistive load as: a) the interval between the point when the ramping input voltage crosses the Turn-on Threshold and the output voltage reaches 90% of its nominal value and b) the interval between the point when the converter is enabled by ON/OFF remote control and time when the output voltage reaches 90% of its nominal value.

When converter is started by applying the input voltage with ON/OFF pin active there is delay of 500msec that was intentionally provided to prevent potential startup issues especially at low input voltages

Input Source Impedance

Because of the switching nature and negative input impedance of DC/DC converters, the input of these converters must be driven from the source with both low AC impedance and DC input regulation.

The FXW converters are designed to operate without external components as long as the source voltage has very low impedance and reasonable voltage regulation. However, since this is not the case in most applications an additional input capacitor is required to provide proper operations of the FXW converter. Specified values for input capacitor are recommendation and need to be adjusted for particular application. Due to large variation between applications some experimentation may be needed.

In many applications, the inductance associated with the distribution from the power source to the input of the converter can affect the stability and in some cases, if excessive, even inhibit operation of the converter. This becomes of great consideration for input voltage at 12V or below.

The DC input regulation, associated with resistance between input power source and input of the converter, plays significant role in particular in low input voltage applications such as 12V battery systems.

Note that input voltage at the input pins of the connector must never degrade below Turn-off threshold under all load operating conditions.

Note that in applications with high pulsating loads additional input as well as output capacitors may be needed. In addition, for EMI conducted measurement, due to low input voltage it is recommended to use 5 μ H LISNs instead of typical 50 μ H LISNs.

Input/Output Filtering

Input Capacitor

Minimum required input capacitance, mounted close to the input pins of the converter, is 1000 μ F with ESR < 0.1 Ω .

Several criteria need to be met when choosing input capacitor: a) type of capacitor, b) capacitance to provide additional energy storage, c) RMS current rating, d) ESR value that will ensure that output impedance of the input filter is lower than input impedance of the converter and its variation over the temperature.

Since inductance of the input power cables could have significant voltage drop due to rate of change of input current $di(in)/dt$ during transient load operation, an external capacitor on the output of the converter is required to reduce $di(in)/dt$. Another constraint is minimum rms current rating of the input capacitors which is application dependent. One component of input rms current handled by input capacitor is high frequency component at switching frequency of the converter (typ. 400kHz) and is specified under "Input terminal ripple current" i_c . Typical values at full rated load and 24 V_{in} are provided in Section "Characteristic Waveforms" for each model and are in range of 2.5A– 3.6A . It is recommended to use ceramic capacitors for attenuating this component for input terminal ripple current, which is also required to meet requirement for conducted EMI (See EMI Section). The second component of the input ripple current is due to pulsating load current being reflected to the input and electrolytic capacitors usually used for this purpose need to be selected accordingly. Using several electrolytic capacitors in parallel on the input is recommended.

ESR of the electrolytic capacitors, need to be carefully chosen taken into account temperature dependence.

Output Capacitor

Similar considerations apply for selecting external output capacitor. For additional high frequency noise attenuation use of ceramic capacitors is recommended while in order to provide stability of the converter during high pulsating load high value electrolytic capacitor is required. It is recommended to use several electrolytic capacitors in parallel in order to reduce effective ESR. Note that external output capacitor also reduces slew rate of the input current during pulsating load transients as discussed above.

Table 1 shows recommend external output capacitance.

ON/OFF (Pins 1 and 2)

The ON/OFF pin is used to turn the power converter on or off remotely via a system signal and has positive logic. A typical connection for remote ON/OFF function is shown in Fig. 1.

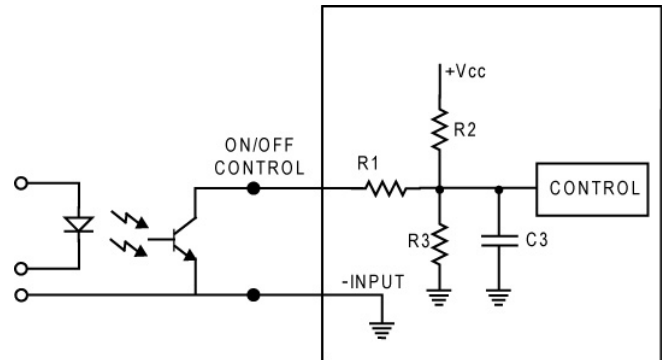

Fig.1: Circuit configuration for ON/OFF function.

The positive logic version turns on when the ON/OFF pin is at logic high and turns off when at logic low. The converter is on when the ON/OFF pin is either left open or external voltage greater than 2V and not more than 12V is applied between ON/OFF pin and – INPUT pin. See the Electrical Specifications for logic high/low definitions.

The negative logic version turns on when the ON/OFF pin is at logic low and turns off when at logic high. The converter is on when the ON/OFF pin is either shorted to –INPUT pin or kept below 0.8V. The converter is off when the ON/OFF pin is either left open or external voltage not more than 12V is applied between ON/OFF pin and –INPUT pin. See the Electrical Specifications for logic high/low definitions.

The ON/OFF pin is internally pulled up to typically 4.5V via resistor and connected to internal logic circuit via RC circuit in order to filter out noise that may occur on the ON/OFF pin. A properly de-bounced mechanical switch, open-collector transistor, or FET can be used to drive the input of the ON/OFF pin. The device must be capable of sinking up to 0.36mA at a low level voltage of ≤ 0.8 V. During logic high, the typical maximum voltage at ON/OFF pin (generated by the converter) is 4.5V, and the maximum allowable leakage current is 160 μ A. If not using the remote on/off feature leave the ON/OFF pin open.

TTL Logic Level - The range between 0.81V and 2V is considered the dead-band. Operation in the dead-band is not recommended.

External voltage for ON/OFF control should not be applied when there is no input power voltage applied to the converter.

Output Overcurrent Protection (OCP)

The converter is protected against overcurrent or short circuit conditions. Upon sensing an overcurrent condition, the converter will switch to constant current operation and thereby begin to reduce output voltage. When the output voltage drops below approx. 50% of the nominal value of output voltage, the converter will shut down.

Once the converter has shut down, it will attempt to restart nominally every 2 seconds. The attempted restart will continue indefinitely until the overload or short circuit conditions are removed or the output voltage rises above 50% of its nominal value.

Once the output current is brought back into its specified range, the converter automatically exits the hiccup mode and continues normal operation.

During initial startup if output voltage does not exceed typical 50% of nominal output voltage within 500 msec after the converter is enabled, the converter will be shut down and will attempt to restart after 2 seconds.

In case of startup into short circuit, internal logic detects short circuit condition and shuts down converter typical 5 msec after condition is detected. The converter will attempt to restart after 2 seconds until the short circuit condition is removed.

Output Overvoltage Protection (OVP)

The converter will shut down if the output voltage across +OUT (Pins 5 and 6) and –OUT (Pins 8 and 9) exceeds the threshold of the OVP circuitry. The OVP circuitry contains its own reference, independent of the output voltage regulation loop. Once the converter has shut down, it will attempt to restart every 2 seconds until the OVP condition is removed.

Note that OVP threshold is set for nominal output voltage and not trimmed output voltage value or remote sense voltage.

Over temperature Protection (OTP)

The FXW converters have non-latching overtemperature protection. It will shut down and disable the output if temperature at the center of the base plate exceeds a threshold of typical 108°C for 9Vin, 112 °C for 12Vin and 115 °C for 24Vin/36Vin. Measured with FXW converter soldered to 5" x 3.5" x 0.07" 4 layers/ 2 Oz Cooper FR4 PCB.

The converter will automatically restart when the base temperature has decreased by approximately 20°C.

Safety Requirements

Basic Insulation is provided between input and the output. The converters have no internal fuse. To comply with safety agencies requirements, a fast-acting or time-delay fuse is to be provided in the unearthed lead. Recommended fuse values are:

- a) 140A for 9V<Vin<18V
- b) 90A for 18V<Vin<36V.

Electromagnetic Compatibility (EMC)

EMC requirements must be met at the end-product system level, as no specific standards dedicated to EMC characteristics of board mounted component dc-dc converters exist.

With the addition of a two stage external filter, the FXW converters will pass the requirements of MILSTD-461F CE102 Base Curve for conducted emissions. Note that 5uH LISN should be used in order to enable operation of the converter at low input voltage.

Remote Sense Pins (Pins 10 and 11)

Sense inputs compensate for output voltage inaccuracy delivered at the load.

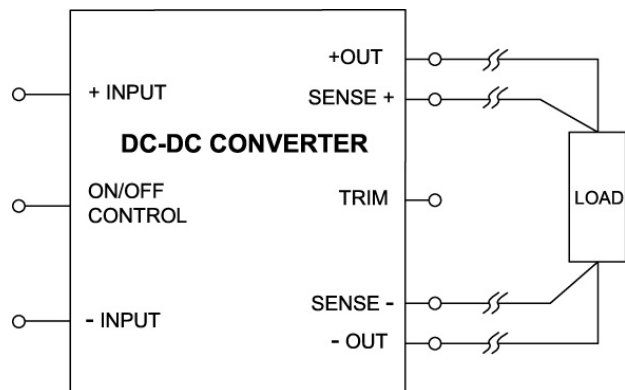

Fig. 2: Circuit configuration for Remote sense function.

The sense input and power Vout pins are internally connected through 100Ω (SENSE+ to +OUT) and 10 Ω (SENSE- to –OUT) resistors enabling the converter to operate without external connection to the Sense. If the Sense function is not used for remote regulation, the user should connect SENSE- (Pin 10) to –OUT (Pins 8 and 9) and SENSE+ (Pin 11) to +OUT (Pins 5 and 6) at the converter pins.

Sense lines must be treated with care in PCB layouts and should run adjacent to DC signals. If cables and discrete wiring is used, it is recommended to use twisted pair, shielded tubing or similar techniques.

The maximum voltage difference between Sense inputs and corresponding power pins should be kept below 1V, i.e.:

$$V(\text{SENSE+}) - V(+\text{OUT}) \leq 1\text{V}$$

$$V(-\text{OUT}) - V(\text{SENSE-}) \leq 1\text{V}$$

Note that maximum output power is determined by maximum output current and highest output voltage at the output pins of the converter:

$$[V(+\text{OUT}) - V(-\text{OUT})] \times I_{\text{out}} \leq P_{\text{out rated}}$$

Output Voltage Adjust/TRIM (Pin 12)

The TRIM (Pin 12) allows user to adjust output voltage 10% up or -40% down relative to rated nominal voltage by addition of external trim resistor. Trim resistor should be mounted close to the converter and connected with short leads. Internal resistor in the converter used for the TRIM is high precision 0.1% with temperature coefficient 25 ppm/°C. The accuracy of the TRIM is therefore determined by tolerance of external Trim resistor. If trimming is not used, the TRIM pin should be left open.

Trim Down – Decrease Output Voltage

Trimming down is accomplished by connecting an external resistor, $R_{\text{trim-down}}$, between the TRIM (pin 12) and the SENSE- (pin 10), with a value of:

$$R_{\text{TRIM-DOWN}} = 499\Delta - 9.98 \text{ [k}\Omega\text{]}$$

Where,

$R_{\text{TRIM-DOWN}}$ = Required value of the trim-down resistor [kΩ]

$V_{\text{O(NOM)}}$ = Nominal value of output voltage [V]

$V_{\text{O(REQ)}}$ = Required value of output voltage [V]

$\Delta = \frac{V_{\text{O(REQ)}} - V_{\text{O(NOM)}}}{V_{\text{O(NOM)}} \text{ [%]}$

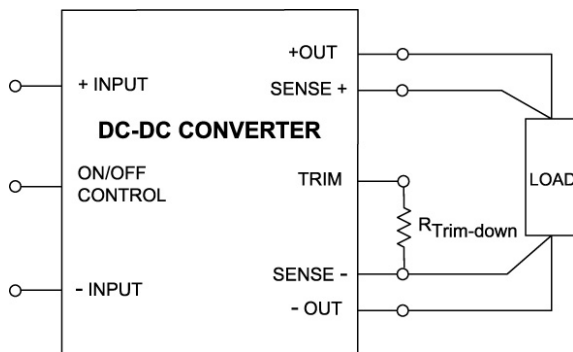

Fig. 3: Circuit configuration for Trim-down function

To trim the output voltage 10% ($\Delta=10$) down, required external trim resistance is:

$$R_{\text{TRIM-DOWN}} = 49910 - 9.98 = 39.92 \text{ k}\Omega$$

Trim Up – Increase Output Voltage

Trimming up is accomplished by connecting an external resistor, $R_{\text{trim-up}}$, between the TRIM (pin 12) and the SENSE+ (pin 11), with a value of:

$$R_{\text{TRIM-UP}} = 4.99 * V_{\text{ONOM}} * (100 + \Delta) 1.25\Delta - (100 + 2\Delta) \Delta \text{ [k}\Omega\text{]}$$

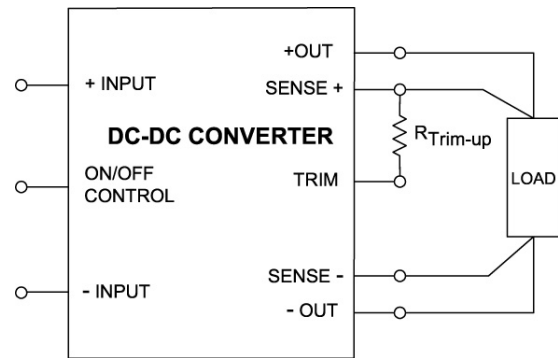

Fig. 4: Circuit configuration for Trim-up function

To trim the output voltage up, for example 24V to 26.4V, $\Delta=10$ and required external resistor is:

$$R_{\text{TRIM-UP}} = 4.99 * 24 * 100 + 101.25 * 10 - 100 + 2 * 1010 = 1015 \text{ k}\Omega$$

Note that trimming output voltage more than 10% is not recommended and OVP may be tripped.

Active Voltage Programming

In applications where output voltage need to be adjusted actively, an external voltage source, such as for example a Digital-to-Analog converter (DAC), capable of both sourcing and sinking current can be used. It should be connected across with series resistor R_g across TRIM (Pin 12) and SENSE- (Pin 10). External trim voltage should not be applied before converter is enabled in order to provide proper startup output voltage waveform and prevent tripping overvoltage protection. Please contact Calex technical representative for more details.

Thermal Consideration

The FXW converter can operate in a variety of thermal environment. However, in order to ensure reliable operation of the converter, sufficient cooling should be provided. The FXW converter is encapsulated in plastic case with metal baseplate on the top. In order to improve thermal



FXW Series, 1000 Watt

DC/DC Converters

performance, power components inside the unit are thermally coupled to the baseplate. In addition, thermal design of the converter is enhanced by use of input and output pins as heat transfer elements. Heat is removed from the converter by conduction, convection and radiation.

There are several factors such as ambient temperature, airflow, converter power dissipation, converter orientation how converter is mounted as well as the need for increased reliability that need to be taken into account in

order to achieve required performance. It is highly recommended to measure temperature in the middle of the baseplate in particular application to ensure that proper cooling of the converter is provided.

A reduction in the operating temperature of the converter will result in an increased reliability.

Thermal Derating

There are two most common applications: 1) the FXW converter is thermally attached to a cold plate inside chassis without any forced internal air circulation; 2) the FXW converter is mounted in an open chassis on system board with forced airflow with or without an additional heatsink attached to the base plate of the FXW converter.

The best thermal results are achieved in application 1) since the converter is cooled entirely by conduction of heat from the top surface of the converter to a cold plate and temperature of the components is determined by the temperature of the cold plate. There is also some additional heat removal through the converter's pins to the metal layers in the system board. It is highly recommended to solder pins to the system board rather than using receptacles. Typical derating output power and current are shown in Figs. 17–26 for various baseplate temperatures up to 105°C. Note that operating converter at these limits for prolonged time will affect reliability.

Soldering Guidelines

The ROHS-compliant through-hole FXW converters use Sn/Ag/Cu Pb-free solder and ROHS-compliant component. They are designed to be processed through wave soldering machines. The pins are 100% matte tin over nickel plated and compatible with both Pb and Pb-free wave soldering processes. It is recommended to follow specifications below when installing and soldering FXW converters. Exceeding these specifications may cause damage to the FXW converter.

Wave Solder Guideline For Sn/Ag/Cu based solders	
Maximum Preheat Temperature	115 °C
Maximum Pot Temperature	270 °C
Maximum Solder Dwell Time	7 seconds
Wave Solder Guideline For Sn/Pb based solders	
Maximum Preheat Temperature	105 °C
Maximum Pot Temperature	250 °C
Maximum Solder Dwell Time	6 seconds

FXW converters are not recommended for water wash process. Contact the factory for additional information if water wash is necessary.

Test Configuration

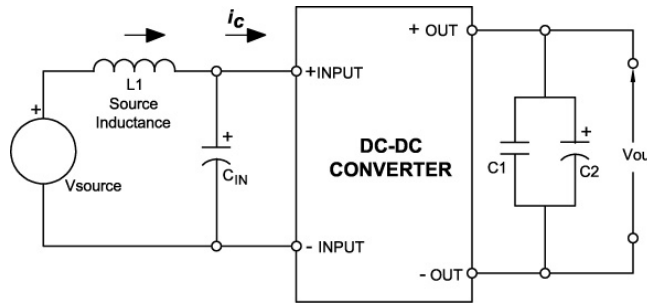

Fig. 5: Test setup for measuring input reflected ripple currents i_c

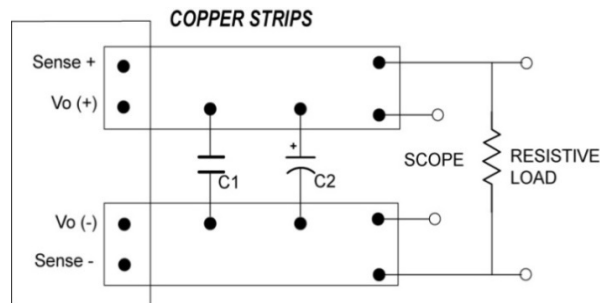

Fig. 6: Test setup for measuring output voltage ripple, startup and step load transient waveforms

Ref. Des.	Manufacturing p/n	24S12.84FXW	24S24.42FXW 24S28.36FXW	24S48.21FXW 24S53.19FXW
L1	N/A	6 ft. cable, AWG 4	100nH	100nH
CIN	MAL214699108E3 (Vishay)	2 x 470 μ F / 72m Ω (650m Ω)	2 x 470 μ F / 72m Ω (650m Ω)	2 x 470 μ F / 76m Ω (650m Ω)
C1	GRM32ER72A475KA12L	10 μ F / 1210 / X7R / 100v	10 μ F / 1210/X7R/100V	10 μ F / 1210 / X7R / 100V
C2	PCR1E471MCL1GS	3 X 470 μ F/ 25V / 15 m Ω (30 m Ω)	N/A	N/A
	PCR1J101MCL1GS (Nichicon)	N/A	3 x 100 μ F / 63V / 24 m Ω (48 m Ω)	N/A
	PCR1K680MCL1GS (Nichicon)	N/A	N/A	3 x 68 μ F / 80V / 28 m Ω (56 m Ω)
	UPS2A221MPD (Nichicon)	N/A	220 μ F / 100V / 100m Ω	220 μ F / 100V / 100m Ω
	MAL214699108E3 (Vishay)	N/A	470 μ F / 72m Ω (650m Ω)	N/A
	MAL214699606E3 (Vishay)	2 X 1500 μ F / 50m Ω (450m Ω)	N/A	N/A
	MAL214699608E3 (Vishay)	2200 μ F / 50m Ω (450m Ω)	N/A	N/A

Table 1: Component values used in test setup from Figs. 5 and 6.
Resistance in () represents ESR value at -40°C for specified capacitor.

Characteristic Curves – Efficiency and Power Dissipation

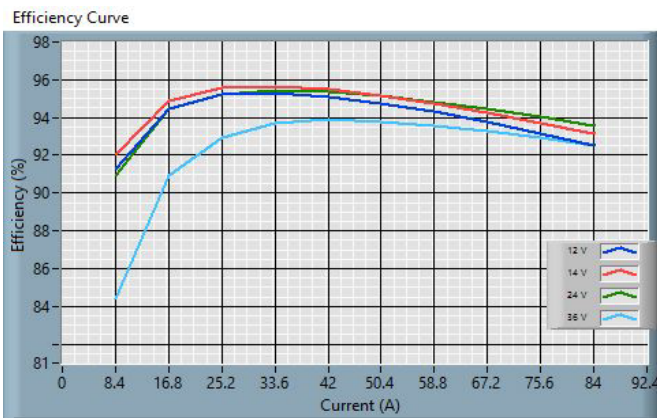

Fig. 7: 24S12.84FXW (ROHS) Efficiency Curve

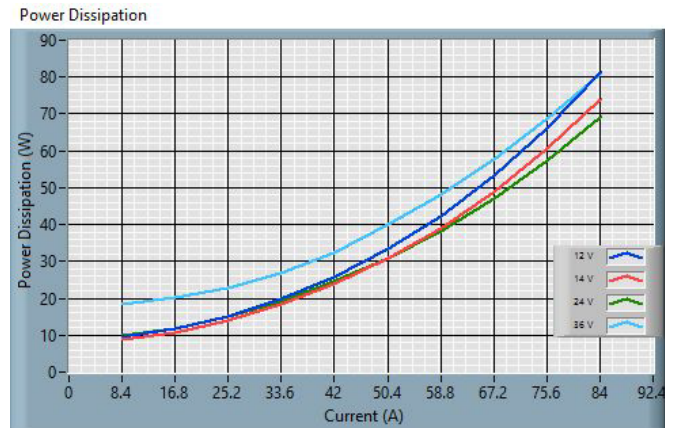

Fig. 8: 24S12.84FXW (ROHS) Power Dissipation

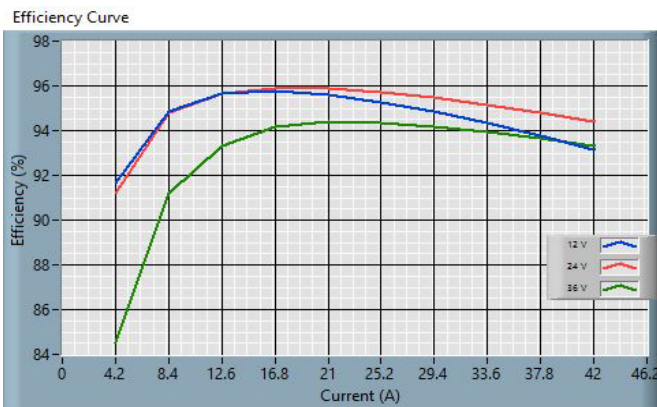

Fig. 9: 24S24.42FXW (ROHS) Efficiency Curve

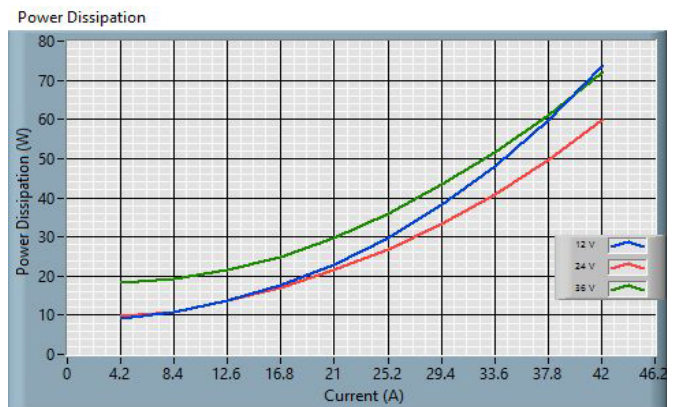

Fig. 10: 24S24.42FXW (ROHS) Power Dissipation

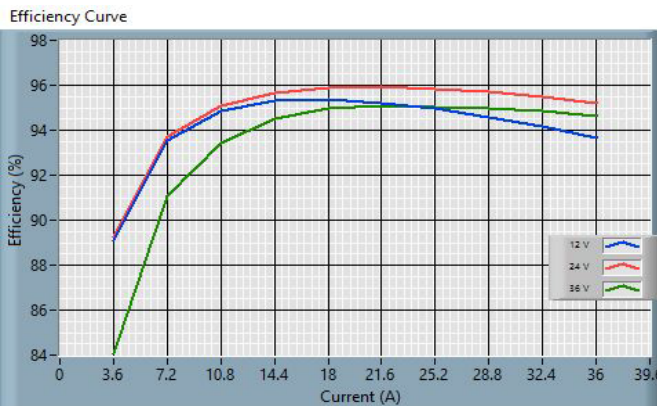

Fig. 11: 24S28.36FXW (ROHS) Efficiency Curve

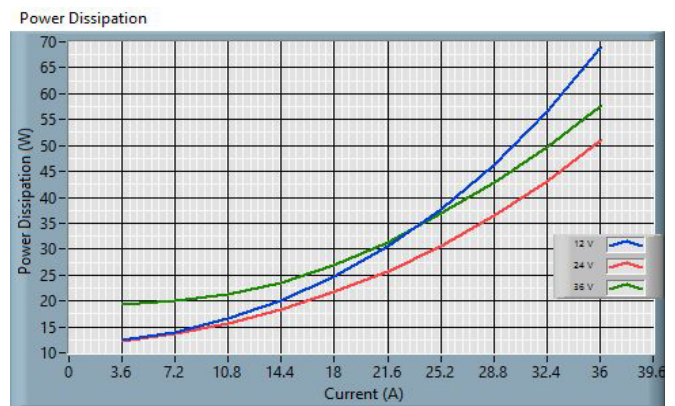

Fig. 12: 24S28.36FXW (ROHS) Power Dissipation

Characteristic Curves – Efficiency and Power Dissipation (Cont'd)

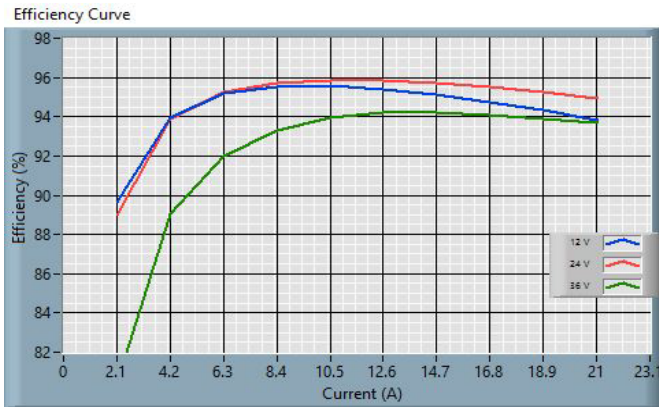

Fig. 13: 24S48.21FXW (ROHS) Efficiency Curve

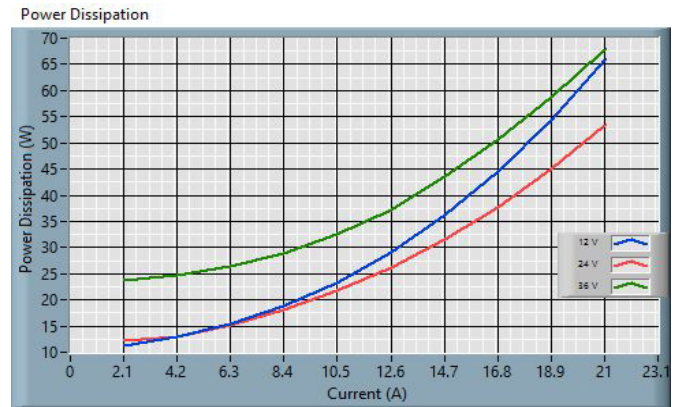

Fig. 14: 24S48.21FXW (ROHS) Power Dissipation

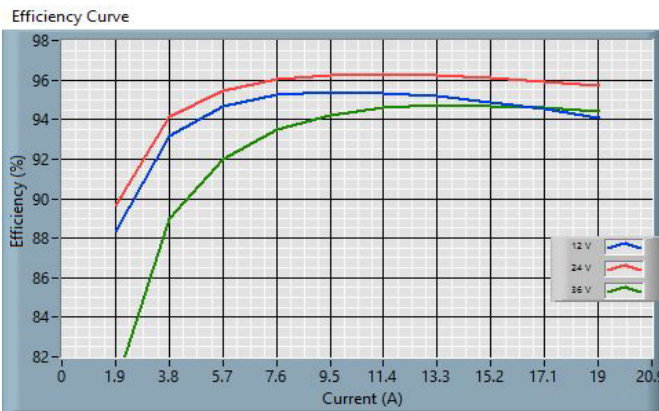

Fig. 15: 24S53.19FXW (ROHS) Efficiency Curve

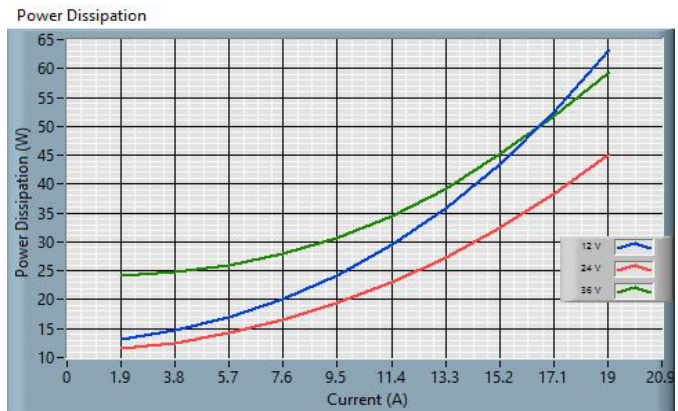

Fig. 16: 24S53.19FXW (ROHS) Power Dissipation

Characteristic Curves – Derating Curves

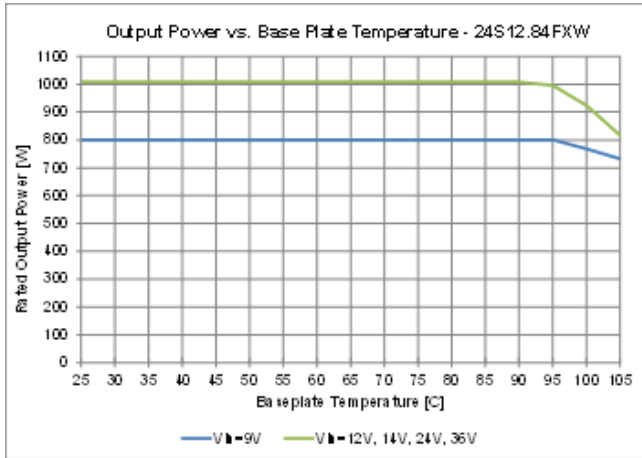

Fig. 17: 24S12.84FXW (ROHS) Derating Curve

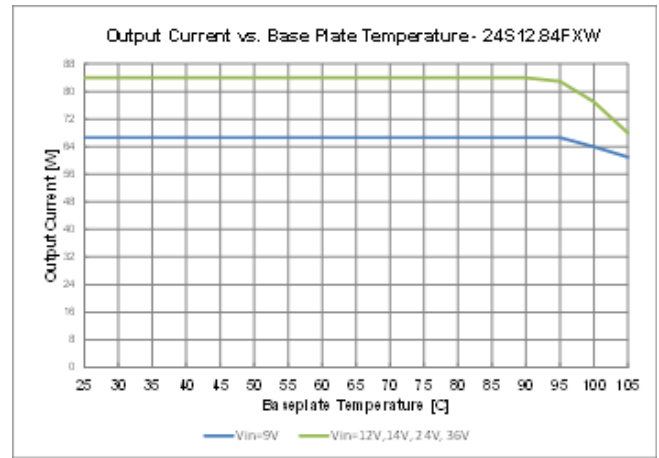

Fig. 18: 24S12.84FXW (ROHS) Derating Curve

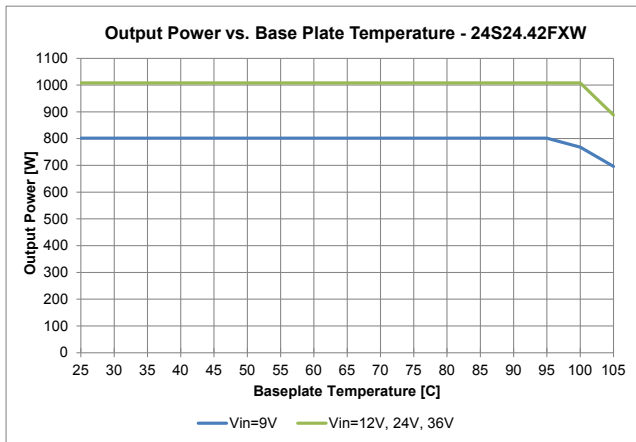

Fig. 19: 24S24.42FXW (ROHS) Derating Curve

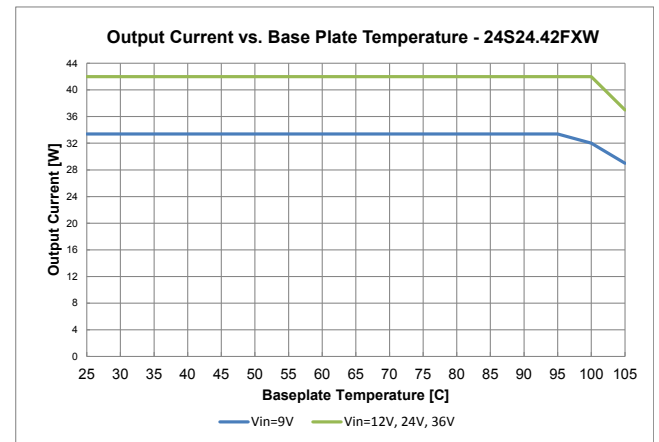

Fig. 20: 24S24.42FXW (ROHS) Derating Curve

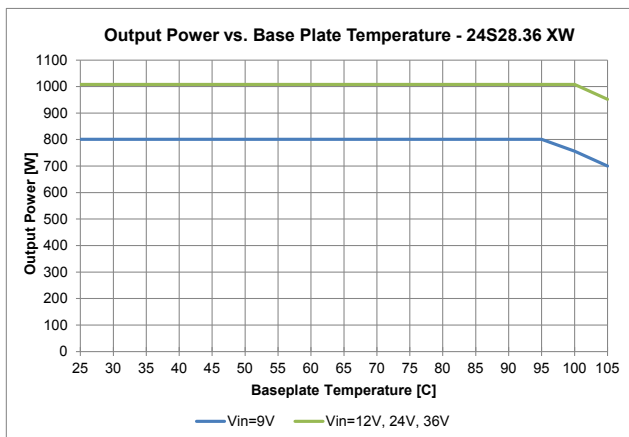

Fig. 21: 24S28.36FXW (ROHS) Derating Curve

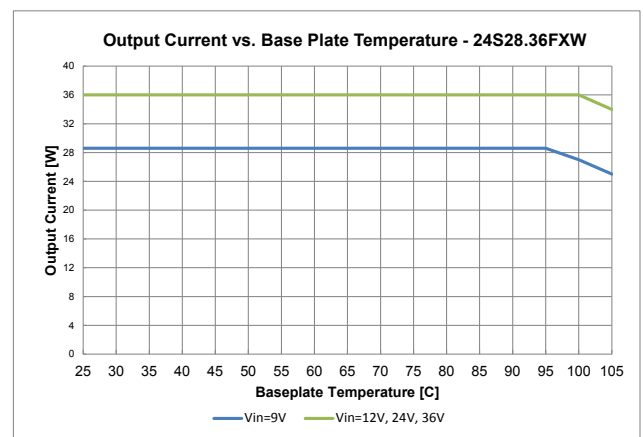

Fig. 22: 24S28.36FXW (ROHS) Derating Curve

Characteristic Curves – Derating Curves (Cont'd)

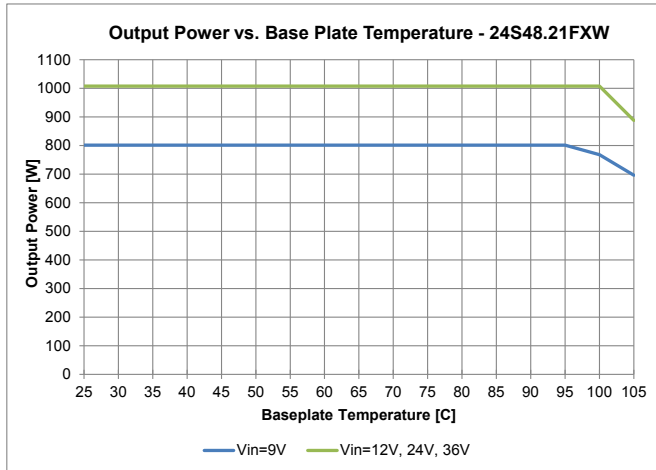

Fig. 23: 24S48.21FXW (ROHS) Derating Curve

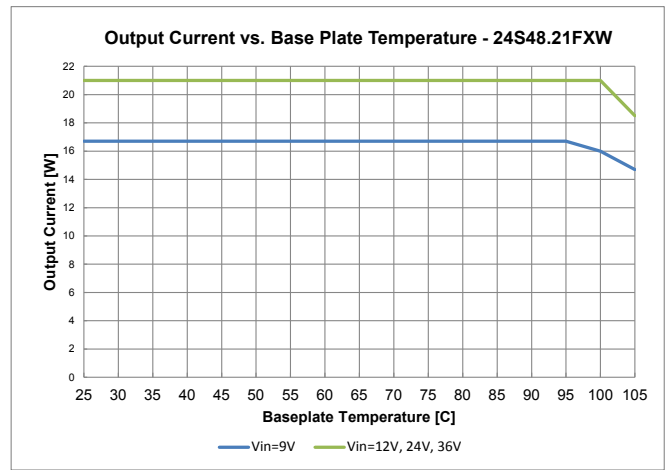

Fig. 24: 24S48.21FXW (ROHS) Derating Curve

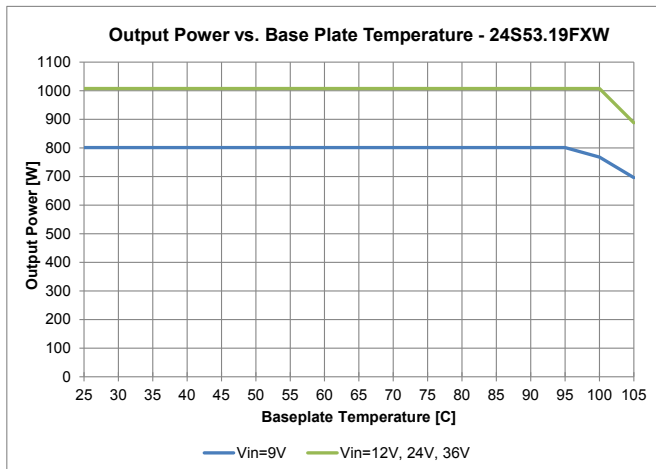

Fig. 25: 24S53.19FXW (ROHS) Derating Curve

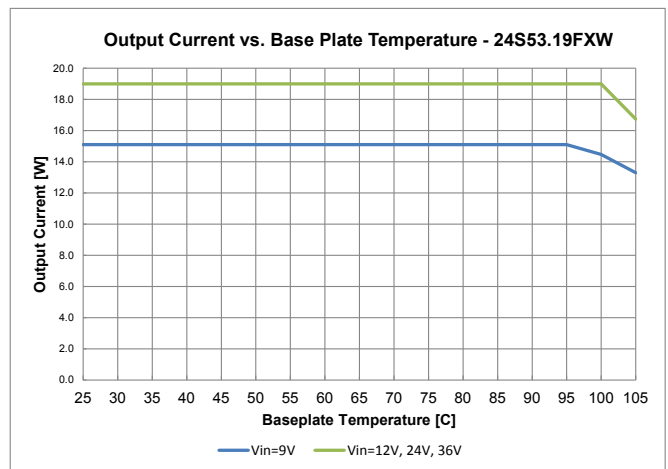

Fig. 26: 24S53.19FXW (ROHS) Derating Curve

Characteristic Waveforms – 24S12.84FXW

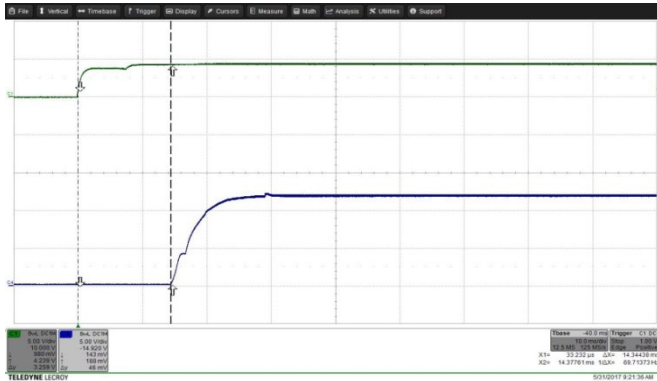

Fig. 27: Turn-on by ON/OFF transient (with V_{in} applied) at full rated load current (resistive) at $V_{in} = 14V$. Top trace (C1): ON/OFF signal (5 V/div.). Bottom trace (C4): Output voltage (5 V/div.). Time: 10 ms/div.

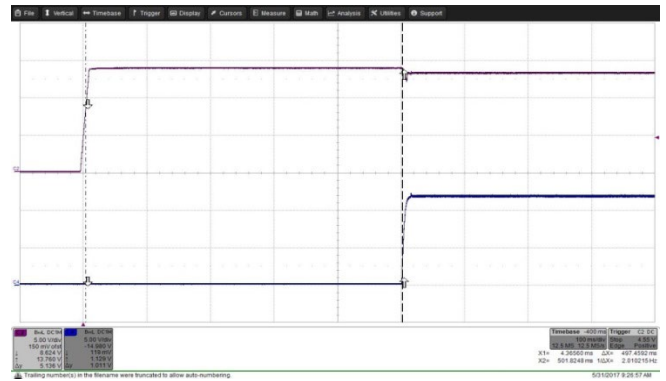

Fig. 28: Turn-on by V_{in} transient (ON/OFF high) at full rated load current (resistive) at $V_{in} = 44V$. Top trace (C2): Input voltage V_{in} (5 V/div.). Bottom trace (C4): Output voltage (5 V/div.). Time: 100 ms/div.

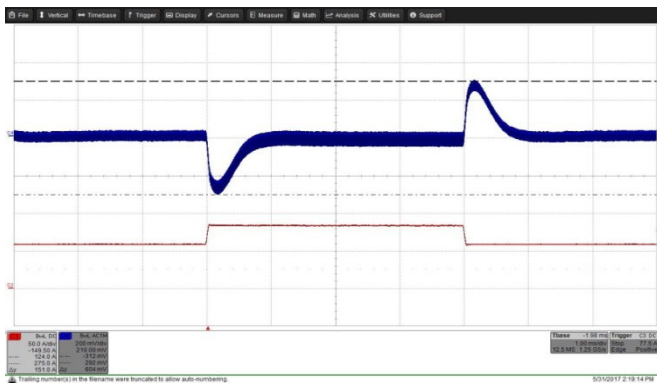

Fig. 29: Output voltage response to load current step change 70% - 100%- 70% (58.5A–84A–58.8A) with $di/dt = 0.5A/\mu s$ at $V_{in} = 14V$. Top trace (C4): Output voltage (200 mV/div.). Bottom trace (C3): Load current (50A/div.). Time: 1ms/div.



Fig. 30: Output voltage response to load current step change 50% - 100%- 50% (42A–84A–42A) with $di/dt = 1A/\mu s$ at $V_{in} = 14V$. Top trace (C4): Output voltage (500 mV/div.). Bottom trace (C3): Load current (50A/div.). Time: 1ms/div.

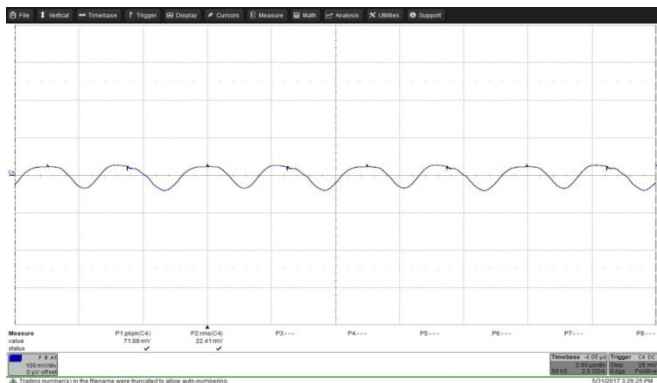

Fig. 31: Output voltage ripple (100 mV/div.) at full rated load current into a resistive load at $V_{in} = 14V$. Time: 2 μs /div

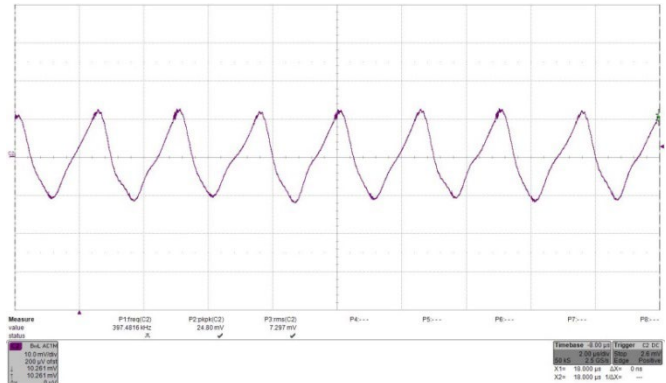

Fig. 32: Input reflected ripple current, i_c (500mA/mV), measured at input terminals at full rated load current at $V_{in} = 24V$. Refer to Fig. 2 for test setup. Time: 2 μs /div. RMS input ripple current is $7.3 \times 0.5A = 3.65A_{RMS}$.

Characteristic Waveforms – 24S24.42FXW

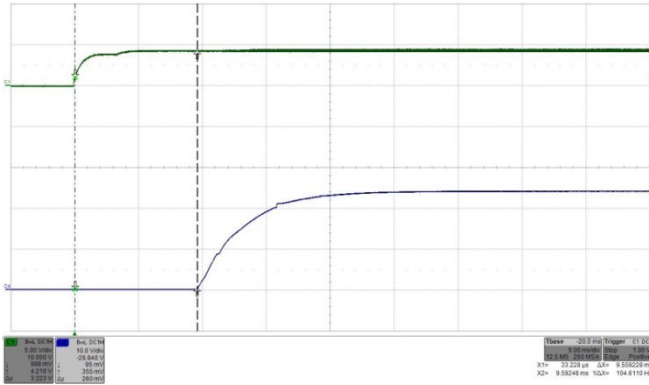

Fig. 33: Turn-on by ON/OFF transient (with V_{in} applied) at full rated load current (resistive) at $V_{in} = 24V$. Top trace (C1): ON/OFF signal (5 V/div.). Bottom trace (C4): Output voltage (10 V/div.). Time: 5 ms/div.

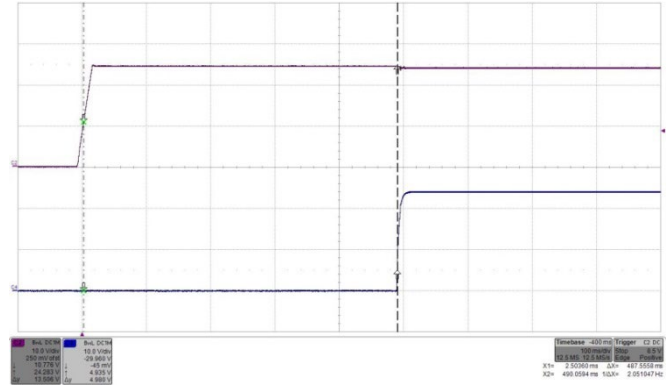

Fig. 34: Turn-on by V_{in} transient (ON/OFF high) at full rated load current (resistive) at $V_{in} = 24V$. Top trace (C2): Input voltage V_{in} (10 V/div.). Bottom trace (C4): Output voltage (10 V/div.). Time: 100 ms/div.

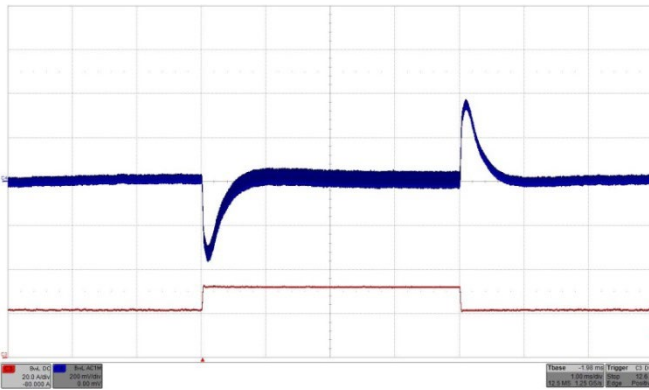

Fig. 35: Output voltage response to load current step change 50% - 75% - 50% (21A–31.5A–21A) with $di/dt = 1A/\mu s$ at $V_{in} = 24V$. Top trace (C4): Output voltage (200 mV/div.). Bottom trace (C3): Load current (20A/div.). $C_o = 470\mu F/70m\Omega$. Time: 1ms/div.

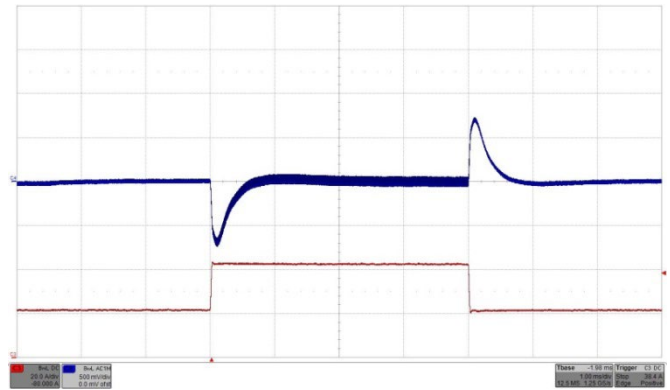

Fig. 36: Output voltage response to load current step change 50% - 100% - 50% (21A–42A–21A) with $di/dt = 1A/\mu s$ at $V_{in} = 24V$. Top trace (C4): Output voltage (500 mV/div.). Bottom trace (C3): Load current (20A/div.). $C_o = 2 \times 470 \mu F/70m\Omega$. Time: 1ms/div.

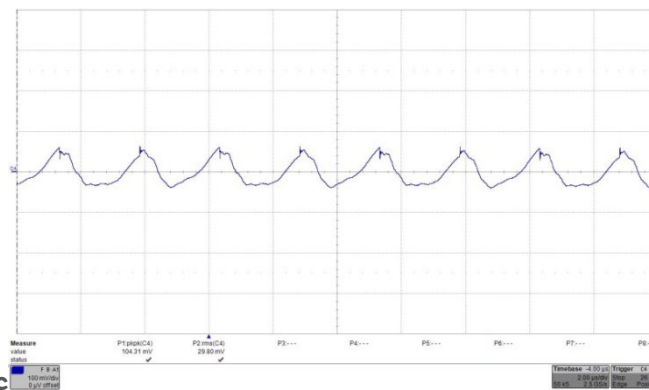

Fig. 37: Output voltage ripple (100 mV/div.) at full rated load current into a resistive load at $V_{in} = 24V$. $C_o = 2 \times 470 \mu F/70m\Omega$. Time: 2 μs /div.

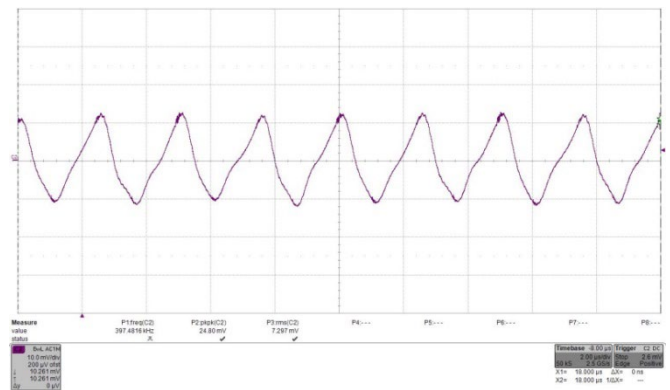

Fig. 38: Input reflected ripple current, i_c (500mA/mV), measured at input terminals at full rated load current at $V_{in} = 24V$. Refer to Fig. 2 for test setup. Time: 2 μs /div. RMS input ripple current is $7.3 \times 0.5A = 3.65A_{RMS}$.

Characteristic Waveforms – 24S28.36FXW

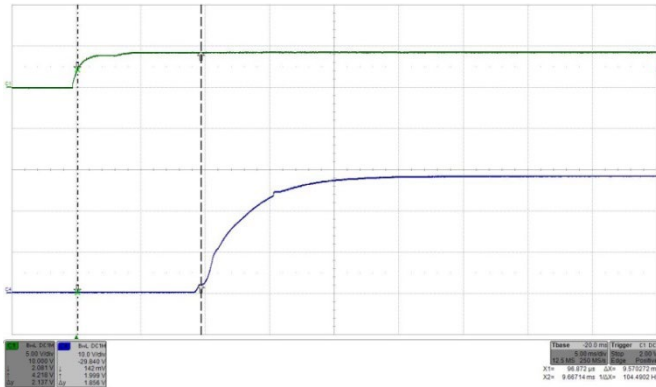

Fig. 39: Turn-on by ON/OFF transient (V_{in} applied) at full rated load current (resistive) at $V_{in} = 24V$. Top trace (C1): ON/OFF signal (5 V/div.). Bottom trace (C4): Output voltage (10 V/div.). Time: 5 ms/div.

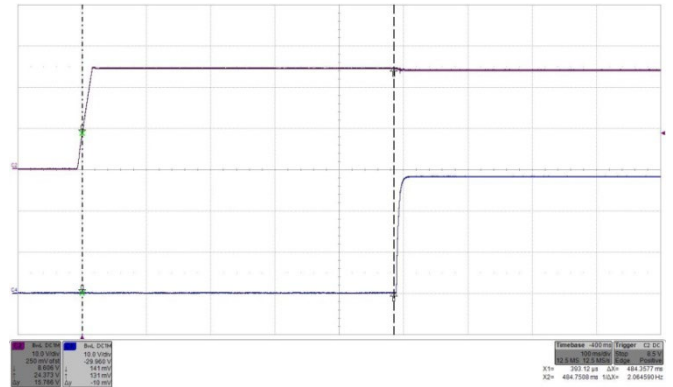

Fig. 40: Turn-on by V_{in} (ON/OFF high) transient at full rated load current (resistive) at $V_{in} = 24V$. Top trace (C2): Input voltage V_{in} (10 V/div.). Bottom trace (C4): Output voltage (10 V/div.). Time: 100 ms/div.

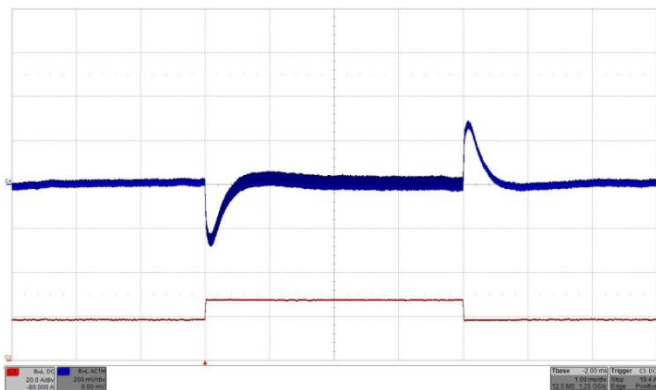

Fig. 41: Output voltage response to load current step change 50% - 75%- 50% (18A–27A–18A) with $di/dt = 1A/\mu s$ at $V_{in} = 24V$. Top trace (C4): Output voltage (200 mV/div.). Bottom trace (C3): Load current (10A/div.). $C_o = 470\mu F/70m\Omega$. Time: 1ms/div.

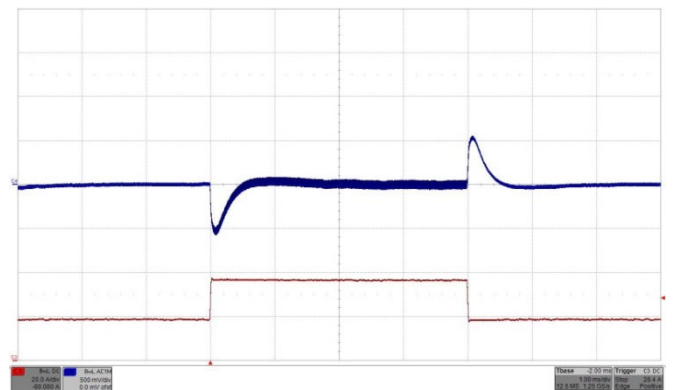

Fig. 42: Output voltage response to load current step change 50% - 100%- 50% (18A–36A–18A) with $di/dt = 1A/\mu s$ at $V_{in} = 24V$. Top trace (C4): Output voltage (500 mV/div.). Bottom trace (C3): Load current (10A/div.). $C_o = 470\mu F/70m\Omega$. Time: 1ms/div.

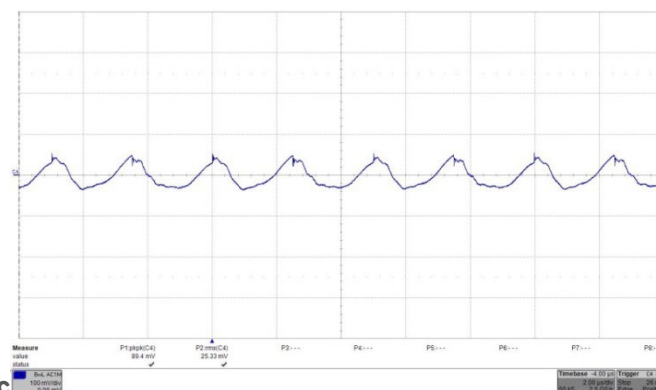

Fig. 43: Output voltage ripple (100 mV/div.) at full rated load current into a resistive load at $V_{in} = 24V$. $C_o = 470\mu F/70m\Omega$. Time: 2 μs /div.

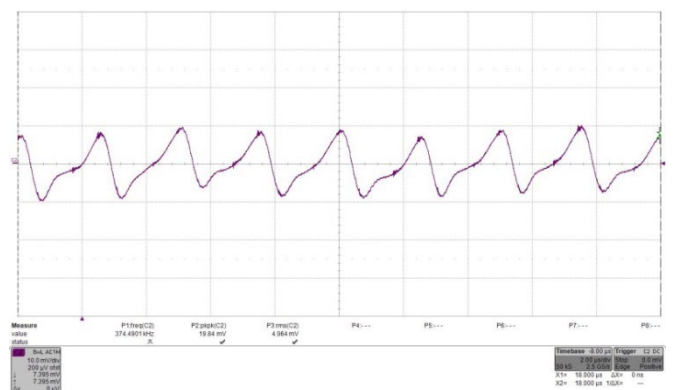

Fig. 44: Input reflected ripple current, i_c (500 mA/div.), measured at input terminals at full rated load current at $V_{in} = 24V$. Refer to Fig. 2 for test setup. Time: 2 μs /div. RMS input ripple current is $4.968 \cdot 0.5A = 2.48A_{RMS}$.

Characteristic Waveforms – 24S48.21FXW

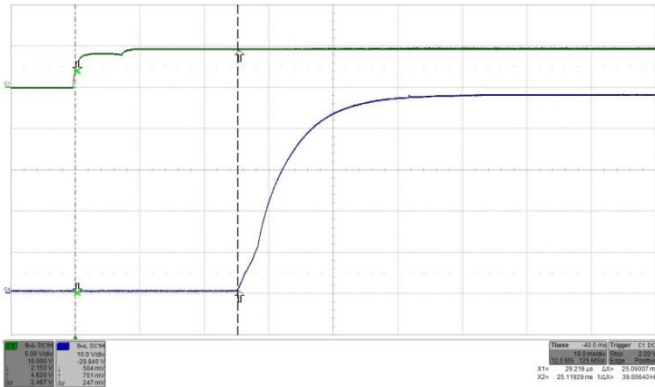

Fig. 45: Turn-on by ON/OFF transient (V_{in} applied) at full rated load current (resistive) at $V_{in} = 24V$. Top trace (C1): ON/OFF signal (5 V/div.). Bottom trace (C4): Output voltage (10 V/div.). Time: 10 ms/div..

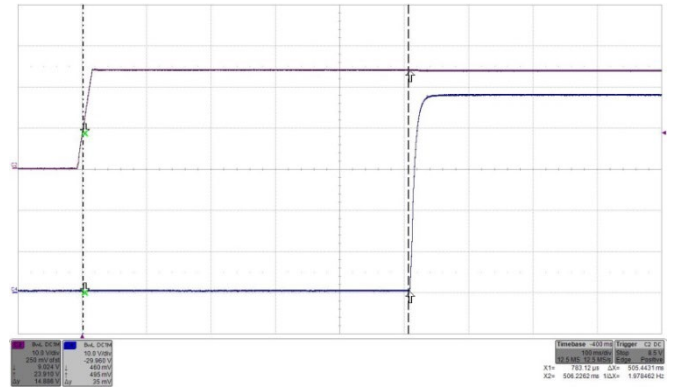

Fig. 46: Turn-on by V_{in} (ON/OFF high) transient at full rated load current (resistive) at $V_{in} = 24V$. Top trace (C2): Input voltage V_{in} (10 V/div.). Bottom trace (C4): Output voltage (10 V/div.). Time: 100 ms/div.

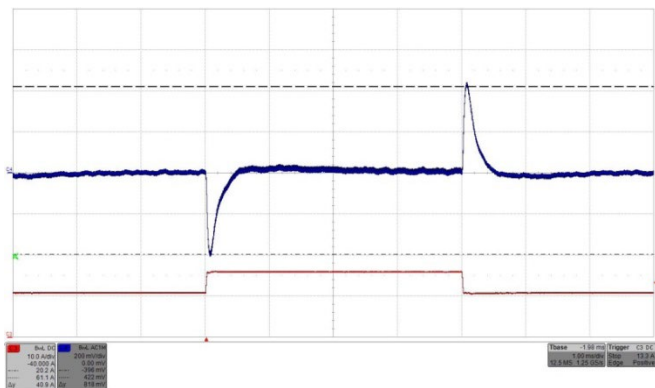

Fig. 47: Output voltage response to load current step change 50% - 75%- 50% (10.5A–15.75A–10.5A) with $di/dt = 1A/\mu s$ at $V_{in} = 24V$. Top trace (C4): Output voltage (200 mV/div.). Bottom trace (C3): Load current (10A/div).. Time: 1ms/div

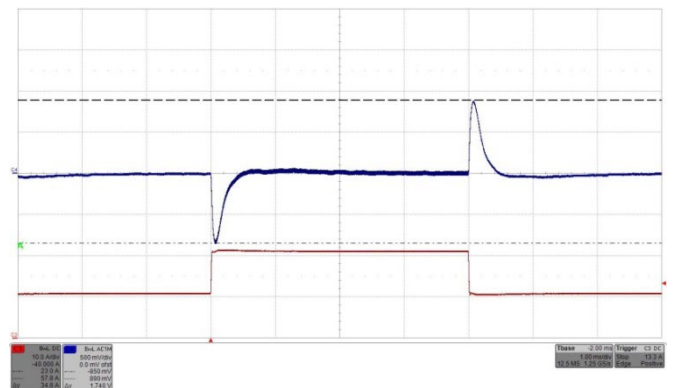

Fig. 48: Output voltage response to load current step change 50% - 100%- 50% (10.5A–21A–10.5A) with $di/dt = 1A/\mu s$ at $V_{in} = 24V$. Top trace (C4): Output voltage (500 mV/div.). Bottom trace (C3): Load current (10A/div.). Time: 1ms/div.

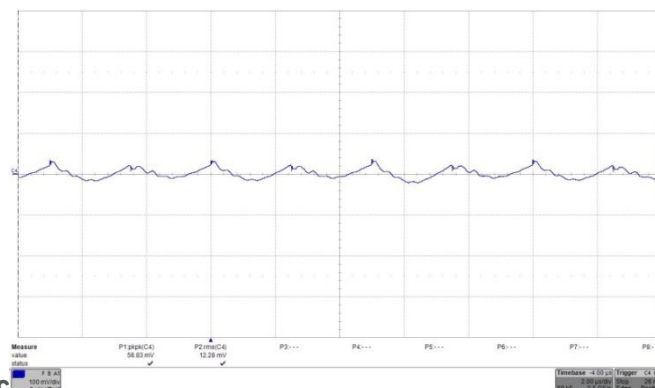

Fig. 49: Output voltage ripple (100 mV/div.) at full rated load current into a resistive load at $V_{in} = 24V$. Time: 2 μs /div.

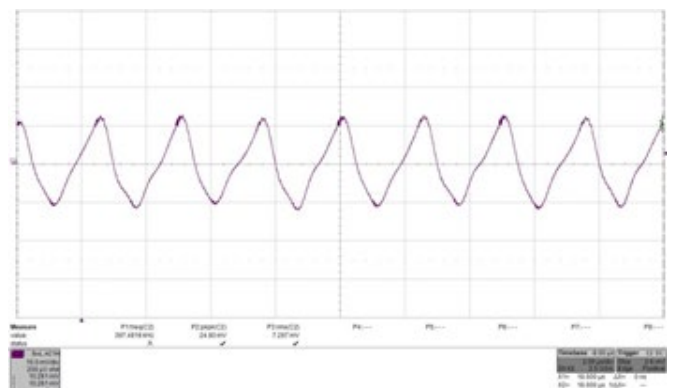

Fig. 50: Input reflected ripple current, i_c (500 mA/div.), measured at input terminals at full rated load current at $V_{in} = 24V$. Refer to Fig. 2 for test setup. Time: 2 μs /div. RMS input ripple current is $7.3 \cdot 0.5A = 3.65A_{RMS}$.

Characteristic Waveforms – 24S53.19FXW

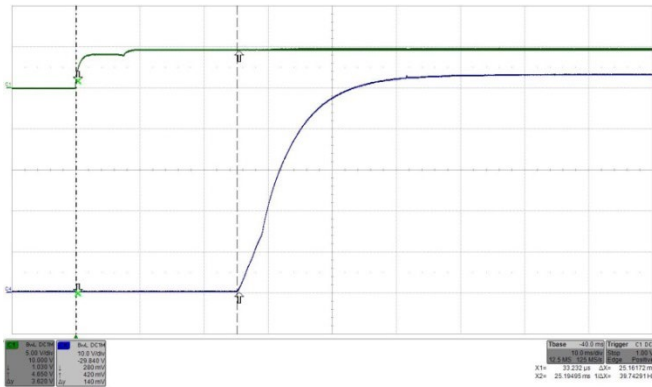

Fig. 51: Turn-on by ON/OFF transient (V_{in} applied) at full rated load current (resistive) at $V_{in} = 24V$. Top trace (C1): ON/OFF signal (5 V/div.). Bottom trace (C4): Output voltage (10 V/div.). Time: 10 ms/div.

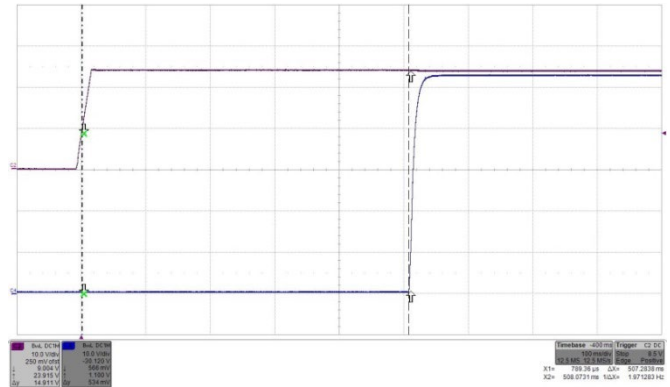

Fig. 52: Turn-on by V_{in} (ON/OFF high) transient at full rated load current (resistive) at $V_{in} = 24V$. Top trace (C2): Input voltage V_{in} (10 V/div.). Bottom trace (C4): Output voltage (10 V/div.). Time: 100 ms/div.

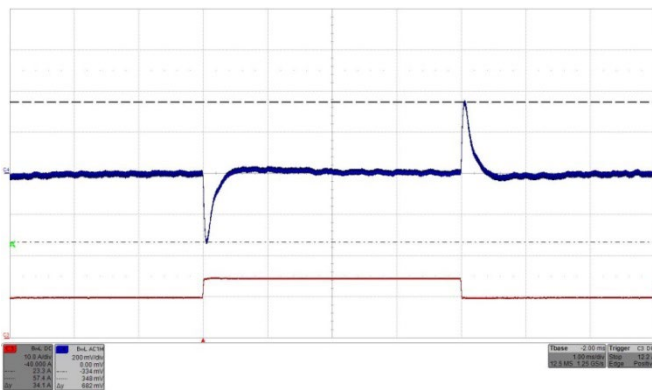

Fig. 53: Output voltage response to load current step change 50% - 75%- 50% (9.5A–14.25A–9.5A) with $di/dt = 1A/\mu s$ at $V_{in} = 24V$. Top trace (C4): Output voltage (200 mV/div.). Bottom trace (C3): Load current (10A/div.). Time: 1ms/div.

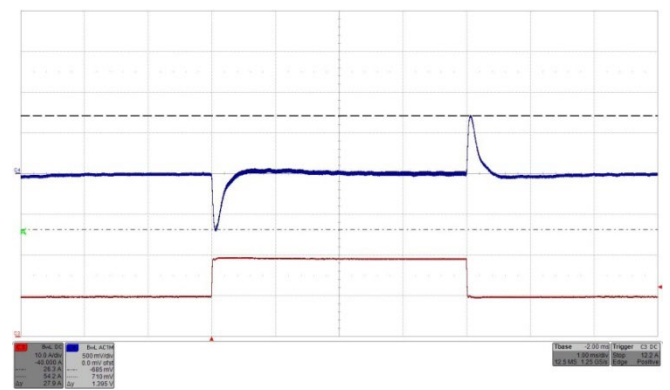

Fig. 54: Output voltage response to load current step change 50% - 100%- 50% (9.5A–19A–9.5A) with $di/dt = 1A/\mu s$ at $V_{in} = 24V$. Top trace (C4): Output voltage (500 mV/div.). Bottom trace (C3): Load current (10A/div.). Time: 1ms/div.

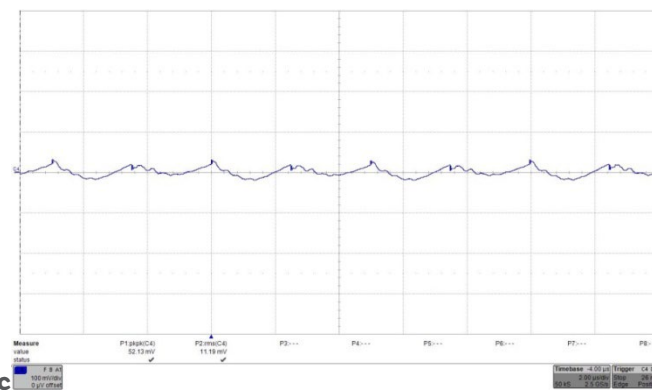

Fig. 55: Output voltage ripple (100 mV/div.) at full rated load current into a resistive load at $V_{in} = 24V$. Time: 2 μs /div.

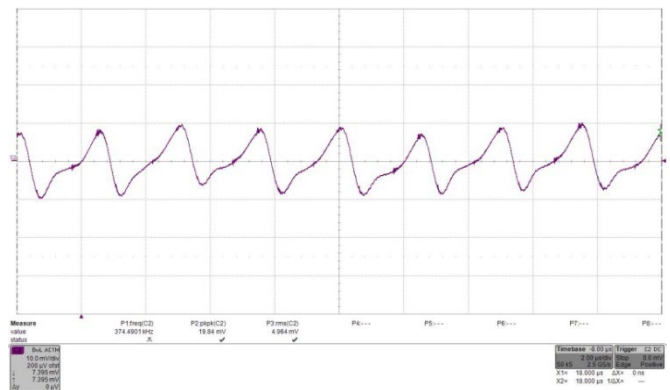
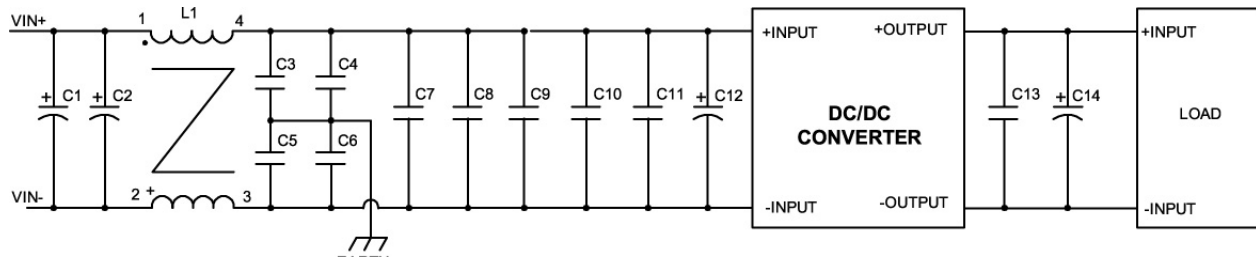

Fig. 56: Input reflected ripple current, i_c (500 mA/div.), measured at input terminals at full rated load current at $V_{in} = 24V$. Refer to Fig. 2 for test setup. Time: 2 μs /div.
RMS input ripple current is $4.968 \times 0.5A = 2.48A_{RMS}$.

EMC Consideration

The filter circuit schematic for suggested input filter configuration as tested to meet the conducted emission limits of MILSTD-461F CE102 Base Curve is shown in Fig. 57. The plots of conducted EMI spectrum measured using 5uH LISNs are shown in Fig. 58.

Note: Customer is ultimately responsible for the proper selection, component rating and verification of the suggested parts based on the end application.



Component Designator	Description
C1, C2, C12, C14	470uF/50V/70mΩ Electrolytic Capacitor (Vishay MAL214699108E3 or equivalent)
C3, C4, C5, C6	4.7nF/1210/X7R/1500V Ceramic Capacitor
C7, C8, C9, C10, C11, C13	10μF/1210/X7R/50V Ceramic Capacitor
L1	CM choke, 130μH, Leakage = 0.6μH (4T on toroid 22.1mm x 13.7 mm x 7.92 mm)

Fig. 57: Typical input EMI filter circuit to attenuate conducted emissions per MILSTD-461F CE102 Base Curve.

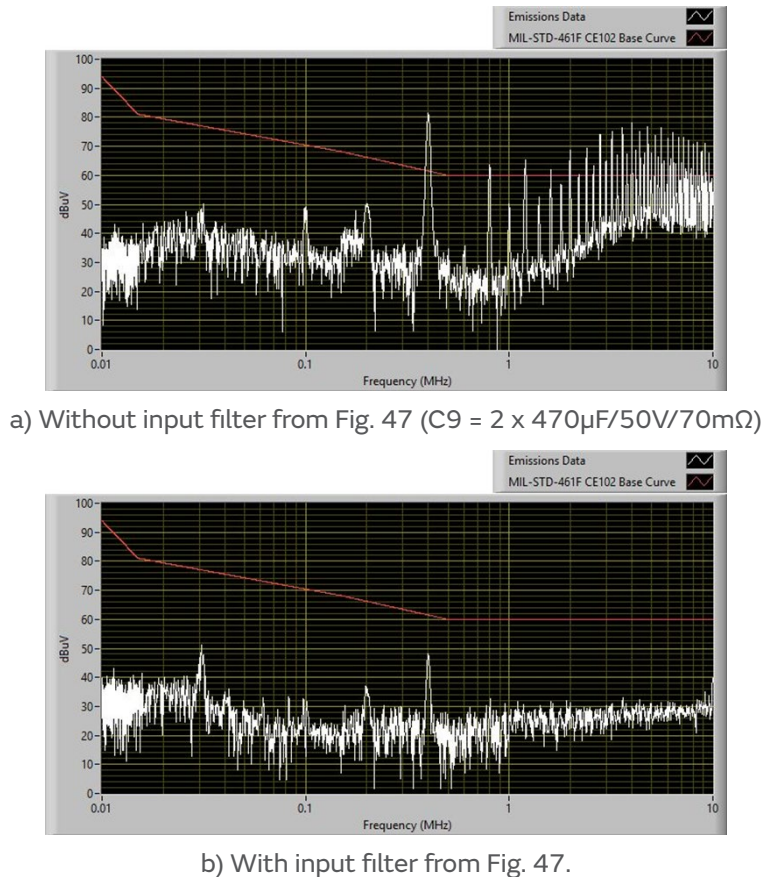
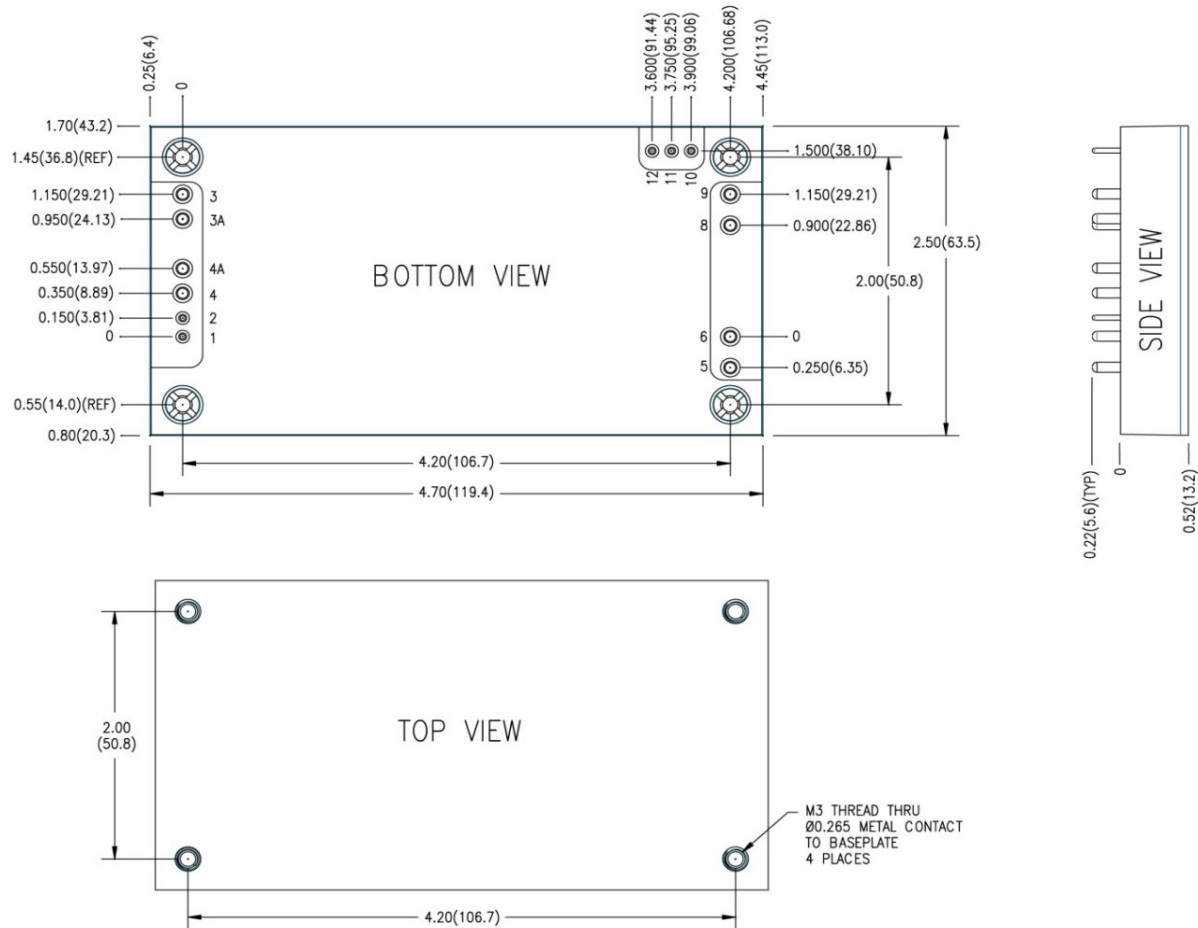

Fig. 58: Input conducted emissions measurement (Typ.) of 24S24.42FXW.

Mechanical Specification



Input/ Output Connections

Pin	Label	Function	Pin	Label	Function
1	+ON/OFF	TTL input with internal pull up, referenced to --ON/OFF pin, used to turn converter on and off	6	+OUT	Positive Output Voltage
2	-ON/OFF	Negative input of Remote ON/OFF	8	-OUT	Negative Output Voltage
3	-INPUT	Negative Input Voltage	9	-OUT	Negative Output Voltage
3A	-INPUT	Negative Input Voltage	10	SENSE-	Negative Remote Sense
4	+INPUT	Positive Input Voltage	11	SENSE+	Positive Remote Sense
4A	+INPUT	Positive Input Voltage	12	TRIM	Used to Trim output voltage +10/-40%
5	+OUT	Positive Output Voltage			

Note:

- Pinout as well as pin number and pin diameter are inconsistent between manufacturers of the full brick converters. Make sure to follow the pin function, not the pin number as well as spec for pin diameter when laying out your board.

NOTES:

Unless otherwise specified:
 All dimensions are in inches [millimeter]
 Tolerances: x.xx in. ±0.02 in. [x.x mm ± 0.5mm]
 x.xxx in. ±0.010 in. [x.xx mm ± 0.25mm]

Torque fasteners into threaded mounting inserts at 10 in.lbs. or less.
 Greater torque may result in damage to unit and void the warranty.