

50 Watt SBMQ48 Series 4:1 Encased DC/DC Converter

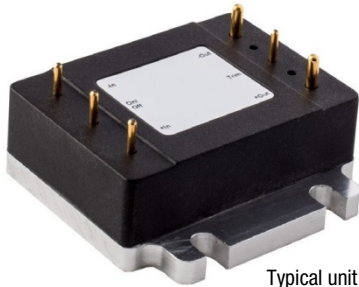

Typical unit

Output Voltage (Vdc)	Output Current (A)	Input Voltage Range (Vdc)
5	10.0	18 to 75
12	4.5	18 to 75

Optimized for harsh environments in industrial/railway applications, the SBM DC-DC converter series offer regulated outputs in an industry-standard sixteenth-brick fully encased package.

FEATURES

- High efficiency synchronous flyback topology
- 18-75 Volts DC wide input range with a single 5 or 12 Volts for an output voltage
- Up to 54 Watts total output power with over-temperature shutdown
- 1.44"x1.04"x0.50" (baseplate without flange)
- Industry standard DOSA "brick" format and pinout
- Extensive self-protection shut down features
- Small footprint DC-DC converter, ideal for high current applications
- Operating temperature range -40 to +85°C with derating
- Stable no-load operation with no required external components
- Certified to UL 60950-1, 2nd Edition, EN60950-1 safety approvals

SAFETY FEATURES

- Basic insulation
- 2250Vdc, Input-to-Output isolation
- UL 60950-1, 2nd Edition
- CAN/CSA-C22.2 NO. 60950-1
- EN 60950-1
- RoHS compliant

PRODUCT OVERVIEW

The world of "brick" DC-DC converters has seen a steady size reduction. The SBM series makes another dramatic size shrink down to a "sixteenth brick" width (1.04 inches) while still retaining a high power output and full 2250 Volt DC isolation. The converter family accepts 18 to 75 Volts DC inputs and delivers fixed outputs regulated up to within $\pm 0.125\%$. The SBM converters are ideal for industrial and railway applications, datacom and telecom applications, cell phone towers, data centers, server farms and network repeaters.

SBM outputs may be trimmed while delivering fast settling to current step loads and no adverse effects from higher capacitive loads. Excellent ripple and noise specifications assure compatibility to circuits using CPU's, ASIC's, programmable logic

and FPGA's. No minimum load is required. For systems requiring controlled startup/shutdown, an external remote On/Off control may use a switch, transistor or digital logic.

Many self-protection features on the SBM series avoid both converter and external circuit hazards. These include input undervoltage shutdown and overtemperature shutdown. The output of these DC-DC converters have current limit using the "hiccup" autorestart technique and the outputs may be short-circuited indefinitely. Additional features include output overvoltage and reverse conduction elimination.

The synchronous flyback topology yields high efficiency for minimal heat buildup and "no fan" operation.

Flanged Baseplate - Standard

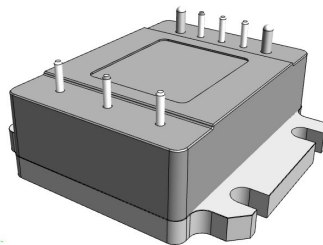

Baseplate W/O Flange - Optional

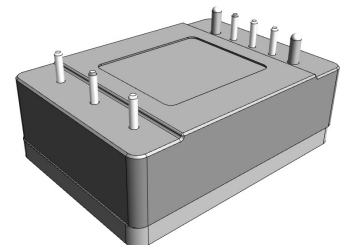

50 Watt SBMQ48 Series 4:1 Encased DC/DC Converter



PERFORMANCE SPECIFICATIONS SUMMARY AND ORDERING GUIDE ①

Root Model	Output						Input				Efficiency		Package (w/o flange)	
	V _{out} (V)	I _{out} (A, max.)	Power (W)	R/N (mV pk-pk)		Regulation (max.) ②		V _{in} Nom. (V)	Range (V)	I _{in} , no load (mA)	I _{in} , full load (A)	Min.	Typ.	Case (inches)
				Typ.	Max.	Line	Load							
48QS5.50SBM	5	10 ③	50	90	130	±0.125%	±0.125%	24/48	18-75	30	1.14	88%	91%	1.44 x 1.04 x 0.50
48QS12.50SBM	12	4.5 ④	54	115	150	±0.125%	±0.125%	24/48	18-75	25	1.24	89%	91%	1.44 x 1.04 x 0.50

① All specifications are at nominal line voltage and full load, +25°C unless otherwise noted. See detailed specifications. Output capacitors are 1 µF ceramic multilayer in parallel with 10 µF and a 220 µF 100V capacitor across the input pins. I/O caps are necessary for our test equipment and may not be needed for your application.

② Regulation specifications describe output voltage deviations from a nominal/midpoint value to either extreme (50% load step).

③ I_{out} = 8A max. if V_{in} < 36V

④ I_{out} = 3.5A max. if V_{in} < 36V

PART NUMBER STRUCTURE

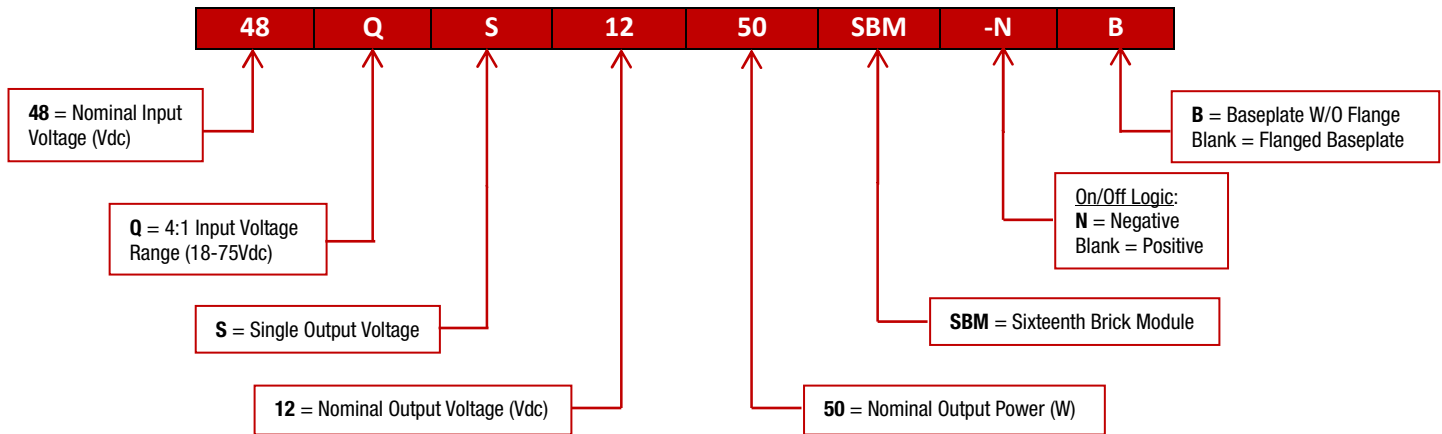

50 Watt SBMQ48 Series

4:1 Encased DC/DC Converter



FUNCTIONAL SPECIFICATIONS, 48QS5.50SBM

ABSOLUTE MAXIMUM RATINGS	Conditions [1]	Minimum	Typical/Nominal	Maximum	Units
Input Voltage, Continuous	Full temperature range	0		75	Vdc
Input Voltage, Transient	Operating or non-operating, tested: 100 mS max. duration	0		100	Vdc
Isolation Voltage	Input to output			2250	Vdc
Input Reverse Polarity	None, install external fuse		None		Vdc
On/Off Remote Control	Power on, referred to -Vin	0		15	Vdc
Output Power		0		50.63	W
Output Current	Current-limited, no damage, short-circuit protected	0		10	A
Storage Temperature Range	Vin = Zero (no power)	-55		125	°C

Absolute maximums are stress ratings. Exposure of devices to greater than any of these conditions may adversely affect long-term reliability. Proper operation under conditions other than those listed in the Performance/Functional Specifications Table is not implied or recommended.

INPUT

Operating voltage range		18	48	75	Vdc
Recommended External Fuse	Fast blow			5	A
Start-up threshold, turn on	Rising input voltage	16	17.5	17.9	Vdc
Undervoltage shutdown, turn off [9]	Falling input voltage	15	16.75	17.5	Vdc
Overvoltage shutdown			NA		Vdc
Reverse Polarity Protection [11]	None, install external fuse		None		Vdc
Internal Filter Type			LC		
Input current					
Full Load Conditions	Vin = nominal		1.14	1.2	A
Low Line	Vin = minimum		2.44	2.51	A
Inrush Transient			0.4		A ² -Sec.
Output in Short Circuit			100	200	mA
No Load Input Current	Iout = minimum, unit=ON		30	60	mA
Shut-Down Mode Input Current			5	10	mA
Reflected (back) ripple current [2]	No filtering		150	200	mAp-p
Reflected (back) ripple current [2]	Measured at input with specified filter		15	30	mAp-p
Pre-biased startup	External output voltage < Vset		Monotonic		

GENERAL and SAFETY

Efficiency	Vin=48V, full load	88	91		%
	Vin=24V, full load	89.5	91		%
Isolation					
Isolation Voltage, Input to Output		2250			Vdc
Isolation Voltage, Input to Baseplate		1500			Vdc
Isolation Voltage, Baseplate to Output		1500			Vdc
Insulation Safety Rating			Basic		
Isolation Resistance			100		MΩ
Isolation Capacitance			1000		pF
Safety (meets the following requirements)	UL-60950-1, CSA-C22.2 No.60950-1, IEC/EN60950-1, 2nd Edition		Yes		
Calculated MTBF [3]	Belcore, Telcordia SR-332, Method 1, class 3, ground fixed, Tambient=25°C		3.0		Hours x 10 ⁶

DYNAMIC CHARACTERISTICS

Fixed Switching Frequency		225	275	325	kHz
Startup Time	Power On to Vout regulated			30	mS
Startup Time	Remote ON to Vout regulated			30	mS
Dynamic Load Response	50-75-50% load step, settling time to within 1% of Vout		100	200	µSec
Dynamic Load Peak Deviation	Same as above,		±180	±240	mV

FEATURES and OPTIONS

Remote On/Off Control [4]					
"N" suffix					
Negative Logic, ON state	ON = Pin grounded or external voltage	-0.1		0.8	V
Negative Logic, OFF state	OFF = Pin open or external voltage	2.5		15	V
Control Current	open collector/drain		1	2	mA
"Blank" suffix					
Positive Logic, ON state	ON = Pin open or external voltage	10		15	V
Positive Logic, OFF state	OFF = Ground pin or external voltage	0		0.7	V
Control Current	open collector/drain		1	2	mA

50 Watt SBMQ48 Series

4:1 Encased DC/DC Converter



FUNCTIONAL SPECIFICATIONS, 48QS5.50SBM (CONT.)

OUTPUT	Conditions [1]	Minimum	Typical/Nominal	Maximum	Units
Total Output Power	See Derating	0.0	50	50.63	W
Voltage					
Nominal Output Voltage	No trim	4.938	5	5.063	Vdc
Setting Accuracy	At 50% load	-1.25		1.25	% of Vset
Output Voltage Range [6]	User-adjustable	-20		10	
Overvoltage Protection [8]	Via magnetic feedback	6.2	6.4	6.6	Vdc
Current					
Output Current Range	Vin=18V to 36V	0		8	
Output Current Range	Vin=36V to 75V	0		10	A
Minimum Load			No minimum load		
Current Limit Inception	98% of Vnom., cold condition	12	14	16.5	A
Short Circuit					
Short Circuit Current	Hiccup technique, autorecovery within 1.25% of Vout		0.6		A
Short Circuit Duration (remove short for recovery)	Output shorted to ground, no damage		Continuous		
Short circuit protection method	Current limiting				
Regulation [5]					
Line Regulation	Vin=min. to max., Vout=nom., nom load		±0.125		V
Load Regulation	Iout=min. to max		±0.125		V
Ripple and Noise [7][10]	With a 1uF 10 uF output caps.		90	130	mV pk-pk
	With a 1uF 100uF tantalum output caps		65		mV pk-pk
Temperature Coefficient	At all outputs		0.02		% of Vout./°C
Remote Sense Compensation [12]	Sense connected at load			10	% of Vout
Maximum Capacitive Loading (10% ceramic, 90% Oscon)	Constant resistance mode , low ESR	0	5000		µF
MECHANICAL					
Outline Dimensions	Baseplate Without Flange		1.44 x 1.04 x 0.5		Inches
(Please refer to outline drawing)	L x W x H		36.47 x 26.31 x 12.7		mm
Outline Dimensions	Flanged Baseplate		1.44 x 1.5 x 0.5		Inches
(Please refer to outline drawing)	L x W x H		36.47 x 38.1 x 12.7		mm
Weight			0.58		Ounces
			16.4		Grams
Through Hole Pin Diameter	Diameter of pins standard		0.06 & 0.04		Inches
			1.524 & 1.016		mm
Through Hole Pin Material			Gold-plated copper alloy with nickel underplate		
TH Pin Plating Metal and Thickness	Nickel subplate		50		µ-inches
	Gold overplate		5		µ-inches
EMI/RFI Shielding			None		
ENVIRONMENTAL					
Operating Ambient Temperature Range	See derating curves	-40		85	°C
Storage Temperature	Vin = Zero (no power)	-55		125	°C
Operating Case Temp	No derating required	-40		105	°C
Thermal Protection/Shutdown	Measured at hotspot	115	125	130	°C
Electromagnetic Interference Conducted, EN55022/CISPR22	External filter is required		B		Class

50 Watt SBMQ48 Series 4:1 Encased DC/DC Converter



TYPICAL PERFORMANCE DATA, 48QS5.50SBM

Efficiency vs. Line Voltage and Load Current @ 25°C – $V_{in} = 18V-36V$

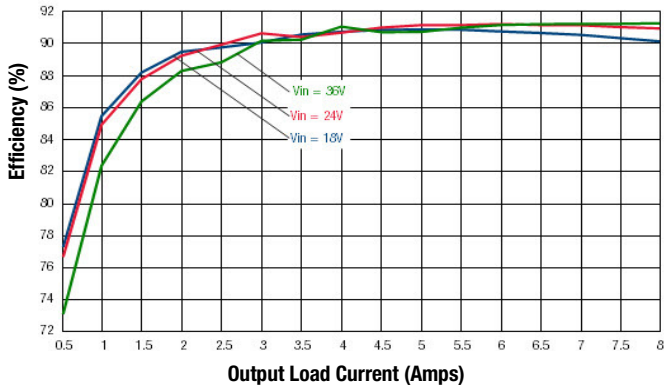

Efficiency vs. Line Voltage and Load Current @ 25°C – $V_{in} = 36V-75V$

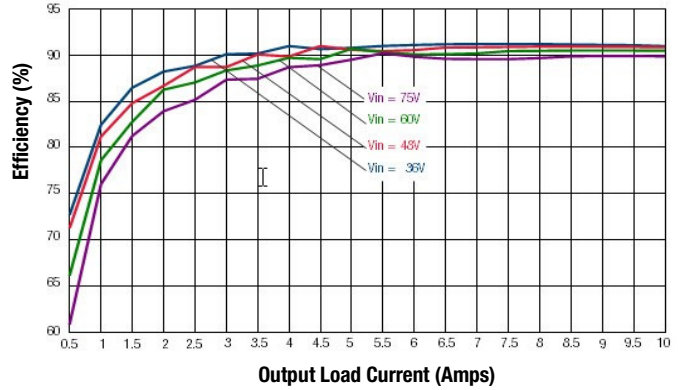

Maximum Current Temperature Derating at Sea Level
($V_{in} = 24V$, airflow is from V_{in-} to V_{in+})

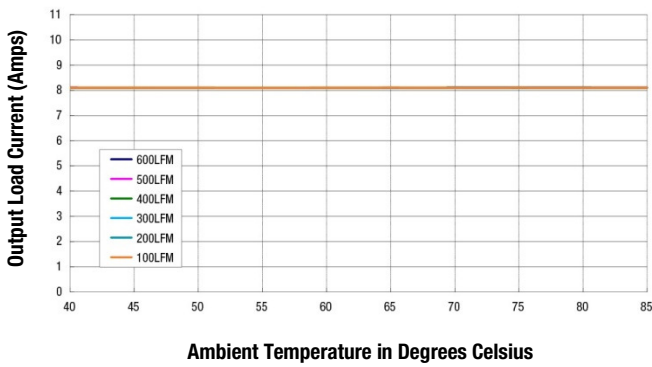

Maximum Current Temperature Derating at Sea Level
($V_{in} = 48V$, airflow is from V_{in-} to V_{in+})

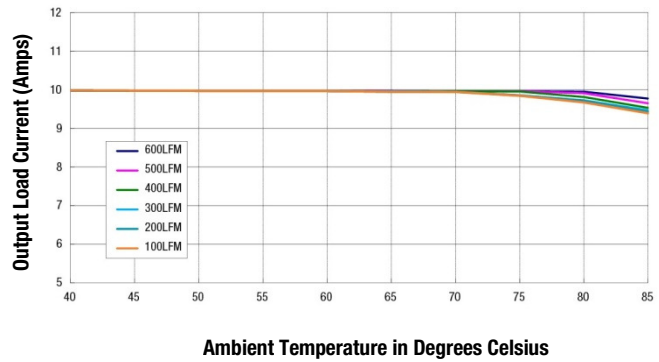

Maximum Current Temperature Derating at Sea Level
($V_{in} = 60V$, airflow is from V_{in-} to V_{in+})

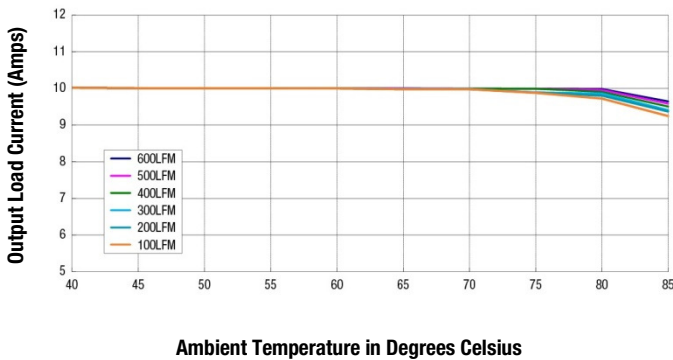

Maximum Current Temperature Derating at Sea Level
($V_{in} = 75V$, airflow is from V_{in-} to V_{in+})

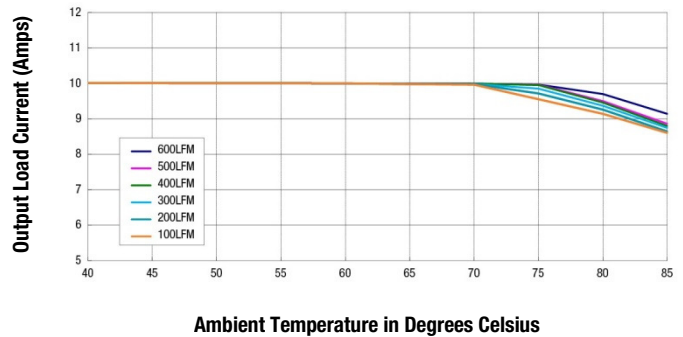

TYPICAL PERFORMANCE DATA, 48QS5.50SBM

Power On Startup Delay
(Vin=0 to 48V, Vout=nom, Iout=10A, Cload=0 uF, Ta=+25°C., Scope BW=20MHz)
Trace 1=Vin, Trace 4=Vout

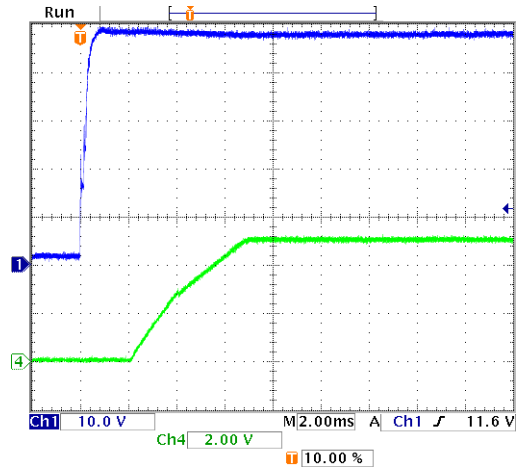

Power On Startup Delay
(Vin=0 to 48V, Vout=nom, Iout=0A, Cload=0 uF, Ta=+25°C., Scope BW=20MHz)
Trace 1=Vin, Trace 4=Vout

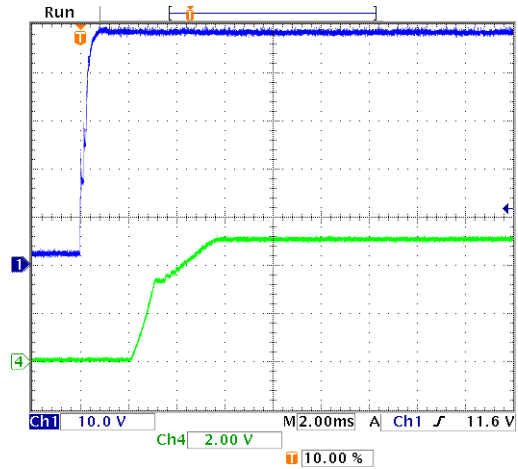

On/Off Enable Delay
(Vin=48V, Vout=nom, Iout=10A, Cload=0 uF, Ta=+25°C., Scope BW=20MHz)
Trace 1=Enable, Trace 4=Vout

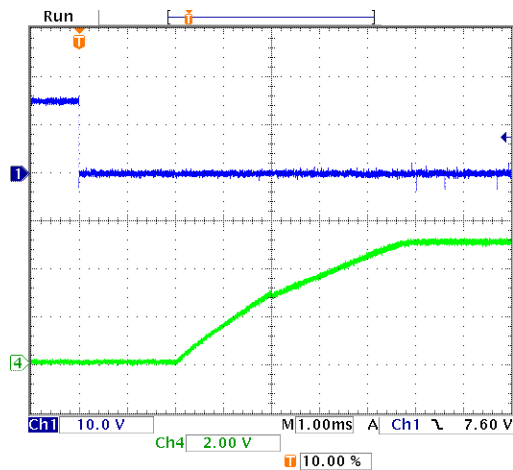

TYPICAL PERFORMANCE DATA, 48QS5.50SBM

Output Ripple and Noise
(Vin=48V, Vout=nom., Iout=10A, Cload=1 uF ceramic II 10uF tantalum, Ta=+25°C., ScopeBW=20MHz)

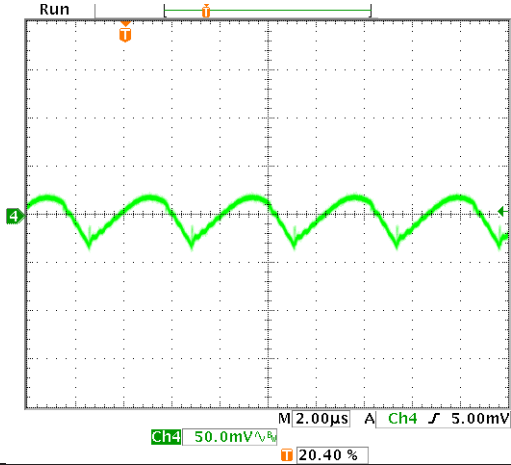

Output Ripple and Noise
(Vin=48V, Vout=nom., Iout=0A, Cload=1 uF ceramic II 10uF tantalum, Ta=+25°C., ScopeBW=20MHz)

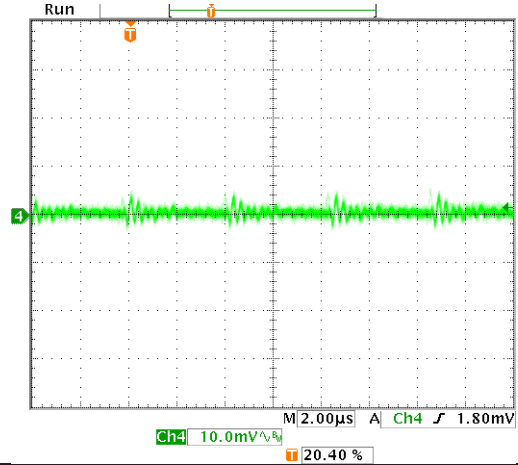

Step Load Transient Response
(Vin=48V, Vout=nom., Iout=50-75-50% of full load, Cload=1 uF ceramic II 10uF tantalum, Ta=+25°C., Scope BW=20MHz Ch1=5Vo, Ch2=Io 2amps/div)

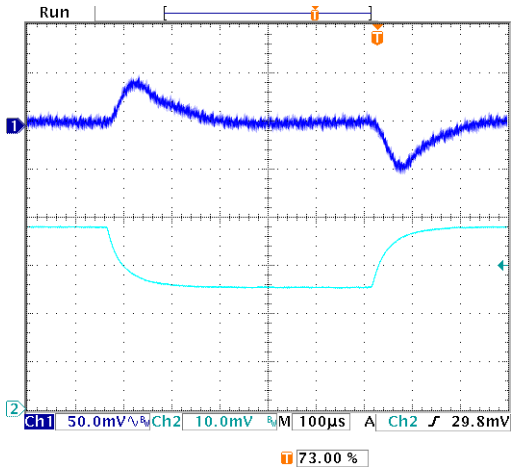

Step Load Transient Response
(Vin=48V, Vout=nom., Iout=50-75-50% of full load, Cload=680uF, Ta=+25°C., Scope BW=20MHz Ch1=5Vo, Ch2=Io 2amps/div)

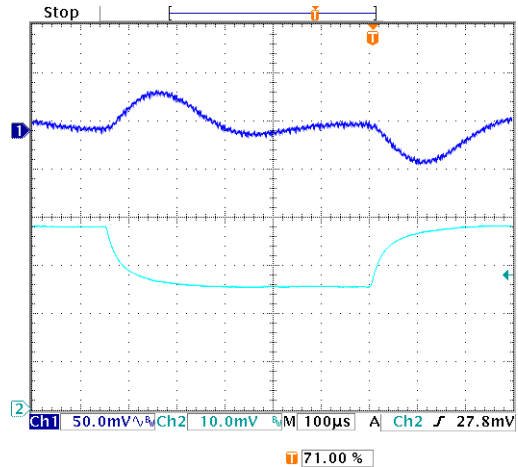

Thermal Derating vs. Baseplate Temperature

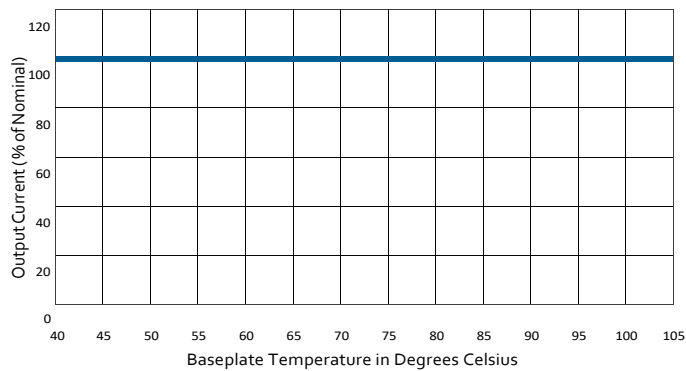

50 Watt SBMQ48 Series 4:1 Encased DC/DC Converter



FUNCTIONAL SPECIFICATIONS, 48QS12.50SBM

ABSOLUTE MAXIMUM RATINGS	Conditions [1]	Minimum	Typical/Nominal	Maximum	Units
Input Voltage, Continuous	Full temperature range	0		75	Vdc
Input Voltage, Transient	Operating or non-operating, 100 mS max. duration	0		100	Vdc
Isolation Voltage	Input to output tested			2250	Vdc
Input Reverse Polarity	None, install external fuse		None		Vdc
On/Off Remote Control	Power on or off, referred to -Vin	0		15	Vdc
Output Power		0		54.54	W
Output Current	Current-limited, no damage, short-circuit protected	0		4.5	A
Storage Temperature Range	Vin = Zero (no power)	-55		125	°C

Absolute maximums are stress ratings. Exposure of devices to greater than any of these conditions may adversely affect long-term reliability. Proper operation under conditions other than those listed in the Performance/Functional Specifications Table is not implied or recommended.

INPUT					
Operating voltage range		18	48	75	Vdc
Recommended External Fuse	Fast blow		6		A
Start-up threshold	Rising input voltage	16.5	17.2	17.9	Vdc
Undervoltage lockout [9]	Falling input voltage	15	16.5	17.50	Vdc
Overvoltage shutdown	Rising input voltage		None		Vdc
Reverse Polarity Protection [11]	None, install external fuse		None		Vdc
Internal Filter Type			LC		
Input current					
Full Load Conditions	Vin = nominal		1.24	1.28	A
Low Line	Vin = minimum , 3.5A load		2.55	2.63	A
Inrush Transient			0.05		A ² -Sec.
Output in Short Circuit			100	200	mA
No Load Input Current	Iout = minimum, unit=ON		25	60	mA
Shut-Down Mode Input Current (Off, UV, OT)			5	10	mA
Reflected (back) ripple current [2]	Measured at input with specified filter		30	40	mA, pk-pk
Pre-biased startup	External output voltage < Vset		Monotonic		

GENERAL and SAFETY					
Efficiency	Vin=48V, full load	89	91		%
	Vin=24V, full load	89.5	91.5		%
Isolation					
Isolation Voltage, Input to Output		2250			Vdc
Isolation Voltage, Input to Baseplate		1500			Vdc
Isolation Voltage, Baseplate to Output		1500			Vdc
Insulation Safety Rating			Basic		
Isolation Resistance			100		MΩ
Isolation Capacitance			1000		pF
Safety (Designed to meet the following requirements)	UL-60950-1, IEC/EN60950-1, 2nd Edition		Yes		
Calculated MTBF [3]	Per Telcordia SR-332, Method 1, class 3, ground fixed, Tambient=25°C		3.0		Hours x 10 ⁶

DYNAMIC CHARACTERISTICS					
Fixed Switching Frequency		200	230	260	kHz
Power Up Startup Time	Power On to Vout regulated			30	mS
On/Off Startup Time	Remote ON to Vout regulated			30	mS
Dynamic Load Response	50-75-50% load step, settling time to within ±1% of Vout		250	300	µSec
Dynamic Load Peak Deviation	Same as above,		±350	±400	mV

FEATURES and OPTIONS					
Remote On/Off Control [4]					
"N" suffix					
Negative Logic, ON state	ON=Pin grounded or external voltage	-0.1		0.8	Vdc
Negative Logic, OFF state	OFF=Pin open or external voltage	2.5		15	Vdc
Control Current	Open collector/drain, sourcing		1	2	mA
"Blank" suffix					
Positive Logic, ON state	ON=Pin open or external voltage	10		15	Vdc
Positive Logic, OFF state	OFF=Pin grounded or external voltage	0		0.7	Vdc
Control Current	Open collector/drain, sinking		1	2	mA

50 Watt SBMQ48 Series 4:1 Encased DC/DC Converter



FUNCTIONAL SPECIFICATIONS, 48QS12.50SBM (CONT.)

OUTPUT	Conditions [1]	Minimum	Typical/Nominal	Maximum	Units
Total Output Power	See Derating	0	54	54.54	W
Voltage					
Nominal Output Voltage	No trim	11.88	12	12.12	Vdc
Setting Accuracy	At 50% load		±1		% of Vnom.
Output Voltage Range [6]	User-adjustable	-20		10	% of Vnom.
Overvoltage Protection [8]	Via magnetic feedback	13.3	15.3	18	Vdc
Current					
Output Current Range	Vin=18V-36V	0		3.5	A
Output Current Range	Vin=36V-75V	0		4.5	A
Minimum Load			No minimum load		
Current Limit Inception	98% of Vnom., after warmup	5.05	6.4	7.4	A
Short Circuit					
Short Circuit Current	Hiccup technique, autorecovery within ±1.25% of Vout		0.6		A
Short Circuit Duration (remove short for recovery)	Output shorted to ground, no damage		Continuous		
Short circuit protection method	Current limiting				
Regulation [5]					
Line Regulation	Vin=min. to max., Vout=nom., full load			±0.125	%
Load Regulation	Iout=min. to max., Vin=48V			±0.125	%
Ripple and Noise [7][10]	with a 1uF 10uF output caps		115	150	mV pk-pk
Temperature Coefficient	At all outputs		±0.02		% of Vnom./°C
Maximum Capacitive Load	Constant resistance mode, low ESR	0	2200		µF
MECHANICAL					
Outline Dimensions	Baseplate Without Flange		1.44 x 1.04 x 0.5		Inches
(Please refer to outline drawing)	L x W x H		36.47 x 26.31 x 12.7		mm
Outline Dimensions	Flanged Baseplate		1.44 x 1.5 x 0.5		Inches
(Please refer to outline drawing)	L x W x H		36.47 x 38.1 x 12.7		mm
Weight			0.58		Ounces
			16.4		Grams
Through Hole Pin Diameter			0.06 & 0.04		Inches
			1.524 & 1.016		mm
Through Hole Pin Material			Copper alloy		
TH Pin Plating Metal and Thickness	Nickel subplate		50		µ-inches
	Gold overplate		5		µ-inches
EMI/RFI Shielding			None		
ENVIRONMENTAL					
Operating Ambient Temperature Range	No derating, full power, natural convection	-40		85	°C
Operating Case Temperature Range	No derating, full power, natural convection	-40		105	°C
Storage Temperature	Vin = Zero (no power)	-55		125	°C
Thermal Protection/Shutdown	Measured in center	115	125	130	°C
Electromagnetic Interference Conducted, EN55022/CISPR22	External filter is required		B		Class

50 Watt SBMQ48 Series 4:1 Encased DC/DC Converter



TYPICAL PERFORMANCE DATA, 48QS12.50SBM

Efficiency vs. Line Voltage and Load Current @ 25°C

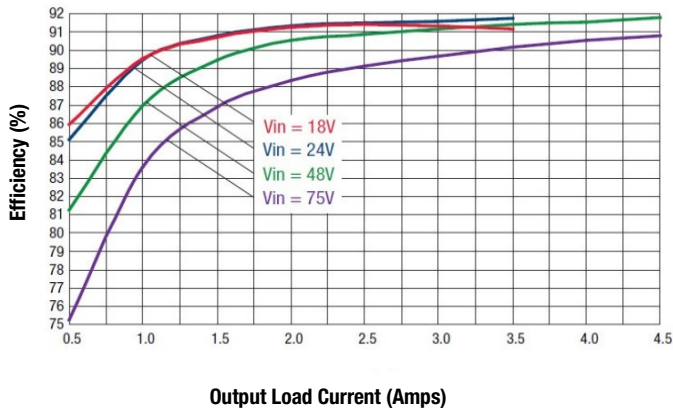

Power Dissipation vs. Load Current @ 25°C

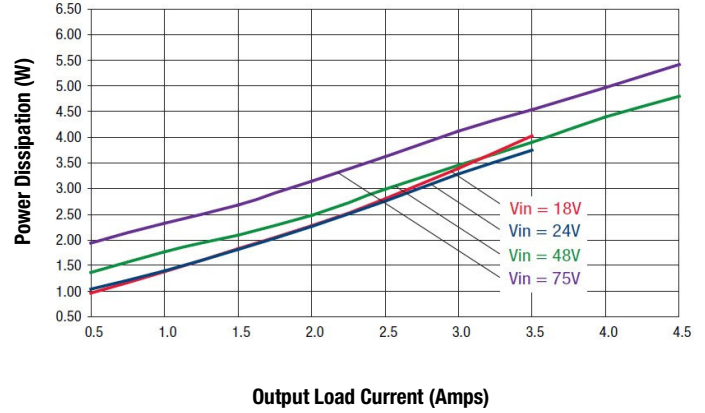

Maximum Current Temperature Derating at Sea Level
(V_{in} = 24V, airflow is from V_{in-} to V_{in+})

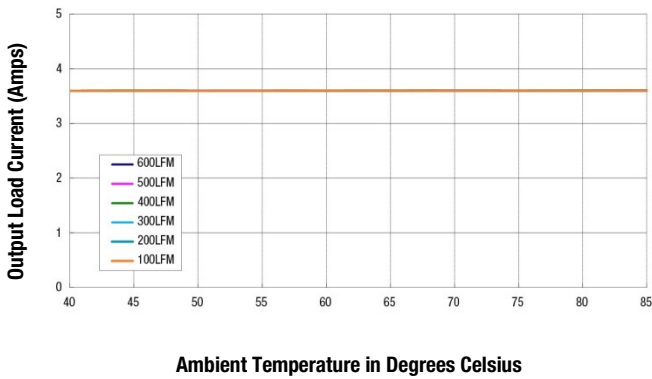

Maximum Current Temperature Derating at Sea Level
(V_{in} = 48V, airflow is from V_{in-} to V_{in+})

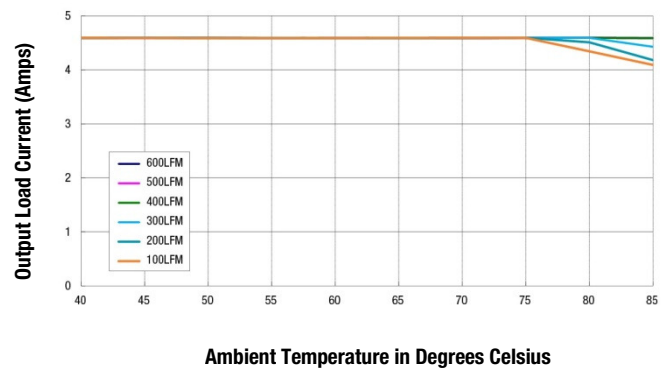

Maximum Current Temperature Derating at Sea Level
(V_{in} = 60V, airflow is from V_{in-} to V_{in+})

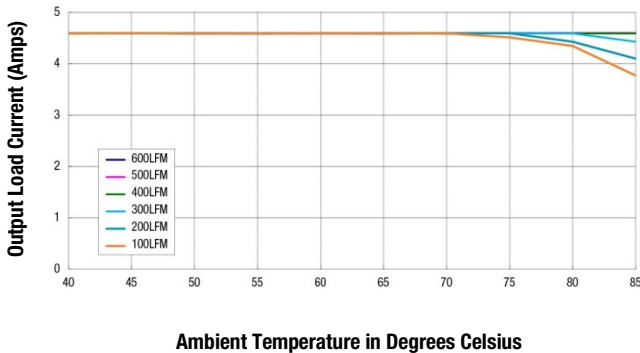

Maximum Current Temperature Derating at Sea Level
(V_{in} = 75V, airflow is from V_{in-} to V_{in+})

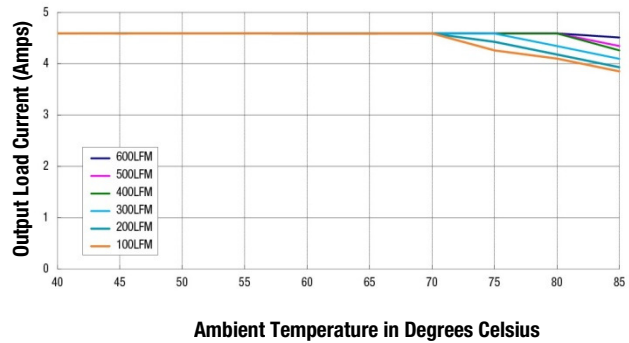

TYPICAL PERFORMANCE DATA, 48QS12.50SBM

Output Ripple and Noise
(Vin=48V, Vout=nom., Iout=no load, Cload=1 μ F ceramic II 10 μ F tantalum, Ta=+25°C., Scope BW=20MHz)

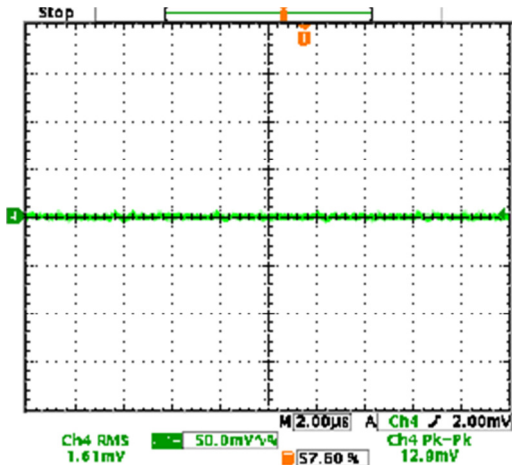

Output Ripple and Noise
(Vin=48V, Vout=nom., Iout=4.5A, Cload=1 μ F ceramic II 10 μ F tantalum, Ta=+25°C., Scope BW=20MHz)

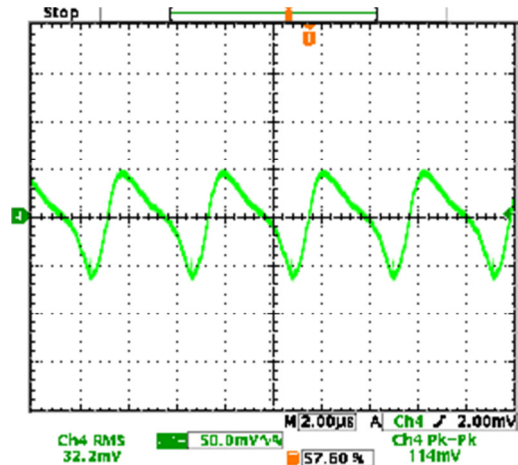

On/Off Enable Delay
(Vin=48V, Vout=nom., Iout=no load, Cload=0 μ F, Ta=+25°C., Scope BW=20MHz)
Trace 1=Enable, Trace 4=Vout

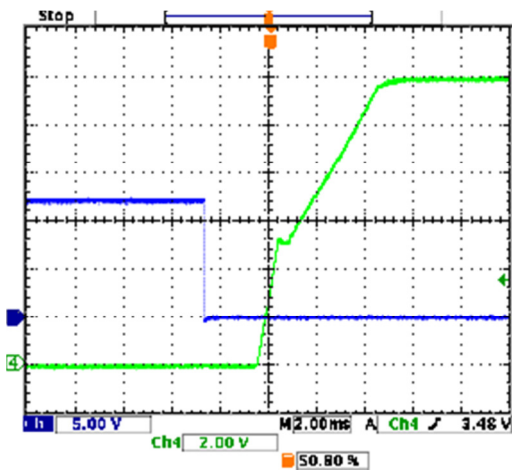

On/Off Enable Delay
(Vin=48V, Vout=nom., Iout=4.5A, Cload=0 μ F, Ta=+25°C., Scope BW=20MHz)
Trace 1=Enable, Trace 4=Vout

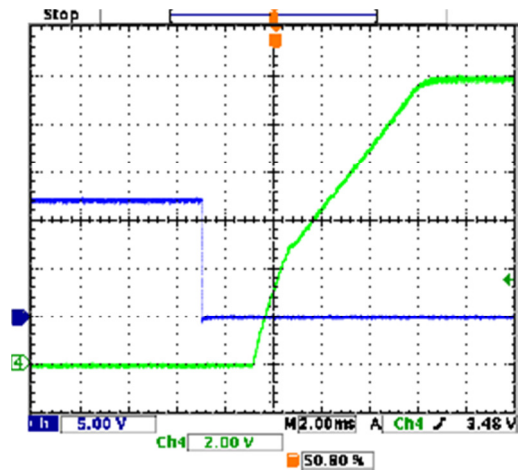

Step Load Transient Response
(Vin=48V, Vout=nom., Iout=50-75-50% of full load, Cload=1 μ F ceramic II 10 μ F tantalum, Ta=+25°C., Scope BW=20MHz)

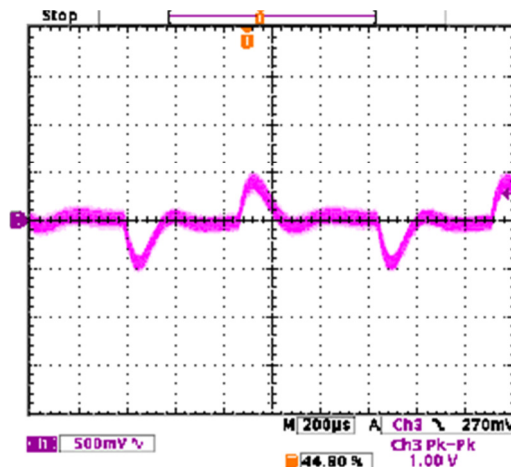

50 Watt SBMQ48 Series 4:1 Encased DC/DC Converter



TYPICAL PERFORMANCE DATA, 48QS12.50SBM

Power On Startup Delay
(Vin=0 to 48V, Vout=nom., Iout=0A, Cload=0 μF, Ta=+25°C., Scope BW=20MHz)
Trace 1=Vin, Trace 4=Vout

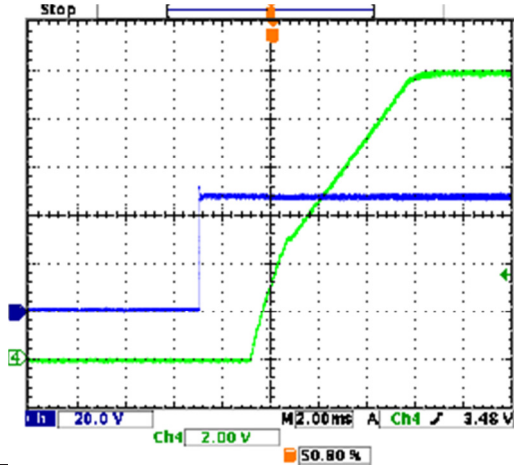

Power On Startup Delay
(Vin=0 to 48V, Vout=nom., Iout=4.5A, Cload=0 μF, Ta=+25°C., Scope BW=20MHz)
Trace 1=Vin, Trace 4=Vout

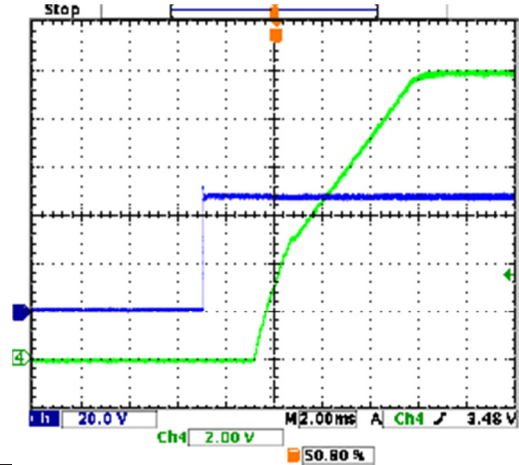

Thermal Derating vs. Baseplate Temperature

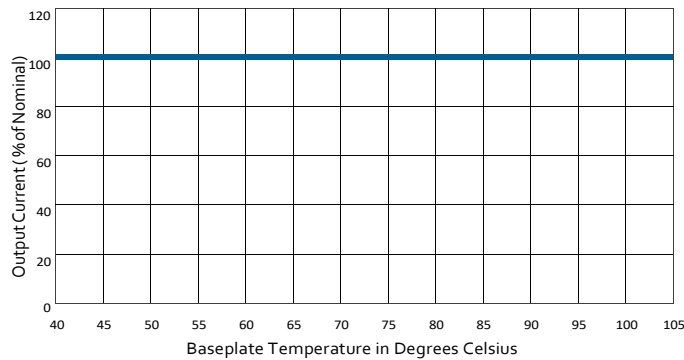

50 Watt SBMQ48 Series

4:1 Encased DC/DC Converter



Performance Specification Notes

1. All specifications are typical unless noted. Ambient temperature = +25°Celsius, V_{in} is nominal, output current is maximum rated nominal. External output capacitance is 1 μ F multilayer ceramic paralleled with 10 μ F electrolytic. All caps are low ESR. These capacitors are necessary for our test equipment and may not be needed in your application. Testing must be kept short enough that the converter does not appreciably heat up during testing. For extended testing, use plenty of airflow. See Derating Curves for temperature performance. All models are stable and regulate within spec without external capacitance.
2. Input Ripple Current is tested and specified over a 5-20 MHz bandwidth and uses a special set of external filters only for the Ripple Current specifications. Input filtering is $C_{in} = 33 \mu$ F, $C_{bus} = 220 \mu$ F, $L_{bus} = 12 \mu$ H. Use capacitor rated voltages which are twice the maximum expected voltage. Capacitors must accept high speed AC switching currents.
3. Mean Time Before Failure (MTBF) is calculated using the Telcordia (Belcore) SR-332 Method 1, Case 3, Issue 1, ground fixed conditions. Operating temperature = +30°C, full output load, natural air convection.
4. The On/Off Control is normally driven from a switch or relay. An open collector/open drain transistor may be used in saturation and cut-off (pinch-off) modes. External logic may also be used if voltage levels are fully compliant to the specifications.
5. Regulation specifications describe the deviation as the input line voltage or output load current is varied from a nominal midpoint value to either extreme (50% load).
6. Do not exceed maximum power ratings or output overvoltage when adjusting output trim values.
7. At zero output current, V_{out} may contain components which slightly exceed the ripple and noise specifications.
8. Output overload protection is non-latching. When the output overload is removed, the output will automatically recover.
9. The converter will shut off if the input falls below the undervoltage threshold. It will not restart until the input exceeds the Input Start Up Voltage.
10. Output noise may be further reduced by installing an external filter. See the Application Notes. Use only as much output filtering as needed and no more. Larger caps (especially low-ESR ceramic types) may slow transient response or degrade dynamic performance. Thoroughly test your application with all components installed.
11. If reverse polarity is accidentally applied to the input, to ensure reverse input protection with full output load, always connect an external fast blow input fuse in series with the + V_{in} input.
12. If remote sense is not used, connect it to its respective V_{out} terminal. Sense is included on 48QS5.50SBM models only.

STANDARDS COMPLIANCE

Parameter	Notes
EN 60950-1/A12:2011	Basic insulation
UL 60950-1/R:2011-12	
CAN/CSA-C22.2 No. 60950-1/A1:2011	
IEC 61000-4-2	ESD test, 8 kV - NP, 15 kV air - NP (Normal Performance)

Note: An external input fuse must always be used to meet these safety requirements.

ENVIRONMENTAL QUALIFICATION TESTING

Parameter	#Units	Test Conditions
Vibration	15	EN 61373:1999 Category I, Class B, Body mounted
Mechanical Shock	15	EN 61373:1999 Category I, Class B, Body mounted
DMTBF(Life Test)	60	Vin nom , units at derating point,101days
Temperature Cycling Test(TCT)	15	-40 °C to 125 °C, unit temp. ramp 15 °C/min.,500cycles
Power and Temperature Cycling Test (PTCT)	5	Temperature operating = min to max, Vin = min to max, Load=50% of rated maximum,100cycles
Temperature ,Humidity and Bias(THB)	15	85 °C85RH,Vin=max, Load=min load,1072Hour(72hours with a pre-conditioning soak, unpowered)
Damp heat test, cyclic	15	EN60068-2-30: Temperatures: + 55 °C and + 25 °C; Number of cycles: 2 (respiration effect); Time: 2 x 24 hours; Relative Humidity: 95%
Dry heat test	5	EN60068-2-2, Vin=nom line, Full load, 85°C for 6 hours.
High Temperature Operating Bias(HTOB)	15	Vin=min to max ,95% rated load, units at derating point,500hours
Low Temperature operating	5	Vin=nom line, Full load,-40°C for 2 hours.
Highly Accelerated Life Test(HALT)	5	High temperature limits, low temperature limits, Vibration limits, Combined Environmental Tests.
EMI	3	Class A in CISPR 22 or IEC62236-3-2(GB/T 24338.4)
ESD	3	IEC 6100-4-2: +/-8kv contact discharge +/-15kv air discharge
Surge Protection	3	EN50121-3-2

Note: Governing Standard BS EN 50155:2007 Railway applications - Electronics equipment used on rolling stock.

50 Watt SBMQ48 Series 4:1 Encased DC/DC Converter



MECHANICAL SPECIFICATIONS (BASEPLATE WITHOUT FLANGE)

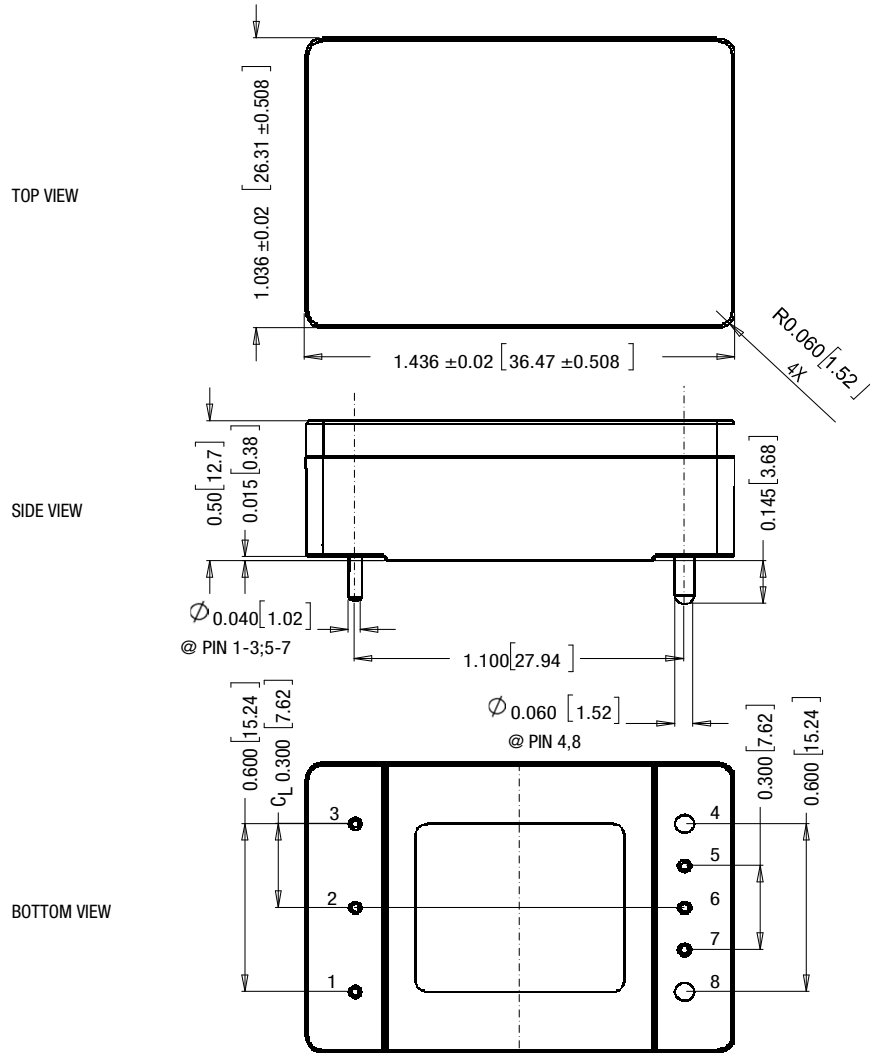

NOTES:

UNLESS OTHERWISE SPECIFIED;

1: ALL DIMENSION ARE IN INCHES[MILLIMETER];

2: THE GAP (Max.0.1mm) AFTER POTTING BAKING BETWEEN AL CASE AND PLASTIC COVER IS ACCEPTABLE;

3: FOR COSMETIC SPECIFICATION AND PRODUCTION WORKMANSHIP STANDARD, PLS FOLLOW THE FILE No.60887;

4: ALL TOLERANCES:

x.x×in, ±0.02in(x.x×mm, ±0.5mm)

x.x×in, ±0.01in(x.x×mm, ±0.25mm)

INPUT/OUTPUT CONNECTIONS			
Pin	Function	Pin	Function
3	-Vin	4	-Vout
		5	-Sense*
2	On/Off Control	6	Output Trim
		7	+Sense*
1	+Vin	8	+Vout

* Sense is included only on model 48QS5.50SBM. Sense pins are omitted on other models.

Note that some competitive units may use different pin numbering or alternate outline views. However, all units are pinout compatible.

It is recommended that no parts be placed beneath the converter.

Material:

Ø .040 Pins: copper alloy

Ø .062 Pins: copper alloy

Finish: (all pins)

Gold (5u"min) over nickel (50u" min)

Dimensions are in inches (mm) shown for ref. only.

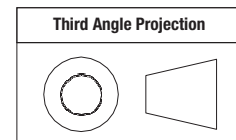

Tolerances (unless otherwise specified):

.XX ± 0.02 (0.5)

.XXX ± 0.010 (0.25)

Angles ± 1°

Components are shown for reference only and may vary between units.

50 Watt SBMQ48 Series 4:1 Encased DC/DC Converter



MECHANICAL SPECIFICATIONS(FLANGED BASEPLATE)

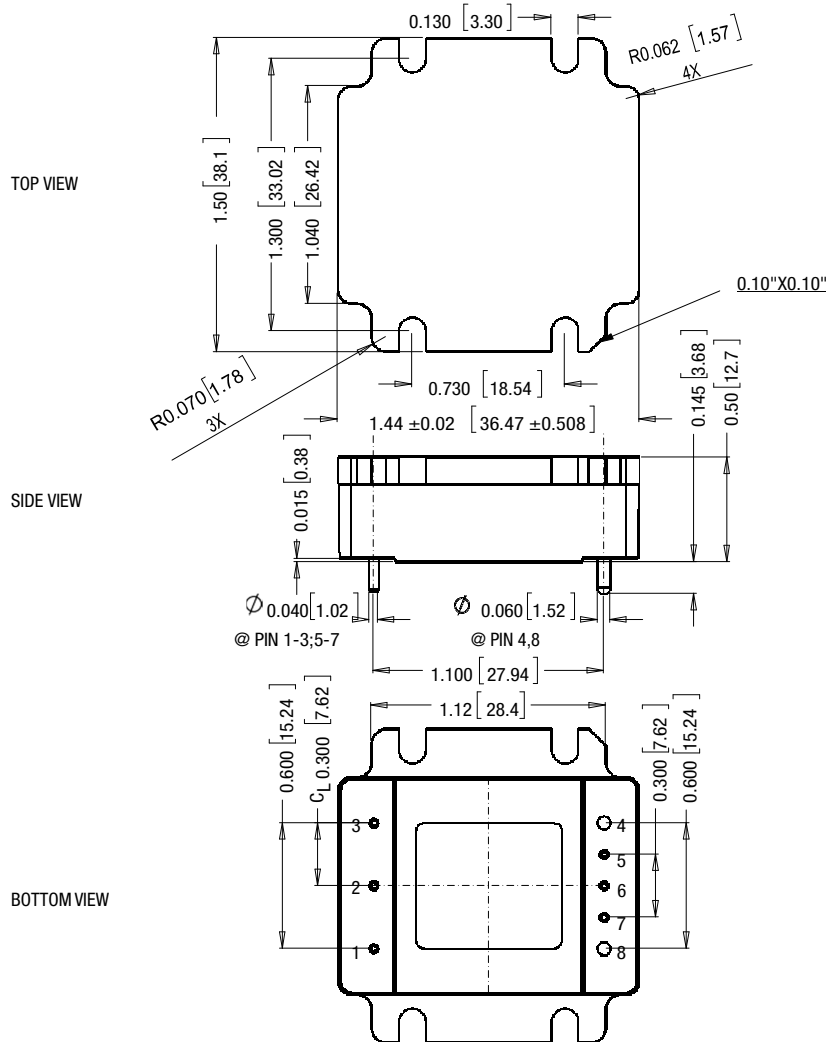

NOTES:

UNLESS OTHERWISE SPECIFIED;

- ALL DIMENSION ARE IN INCHES[MILLIMETER];
- THE GAP (Max.0.1mm) AFTER POTTING BAKING BETWEEN AL CASE AND PLASTIC COVER IS AC CEPTABLE;
- FOR COSMETIC SPECIFICATION AND PRODUCTION WORKMANSHIP STANDARD, PLS FOLLOW THE FILE No.60887;
- ALL TOLERANCES:
 ×.××in, ±0.02in(×.×mm, ±0.5mm)
 ×.×××in, ±0.01in(×.××mm, ±0.25mm)

INPUT/OUTPUT CONNECTIONS			
Pin	Function	Pin	Function
3	-Vin	4	-Vout
		5	-Sense*
2	On/Off Control	6	Output Trim
		7	+Sense*
1	+Vin	8	+Vout

* Sense is included only on model 48QS5.50SBM. Sense pins are omitted on other models.

Note that some competitive units may use different pin numbering or alternate outline views. However, all units are pinout compatible.

It is recommended that no parts be placed beneath the converter.

Material:

- Ø .040 Pins: copper alloy
- Ø .062 Pins: copper alloy
- Finish: (all pins)
Gold (5u"min) over nickel (50u" min)

Dimensions are in inches (mm) shown for ref. only.

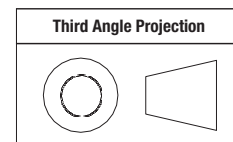

Tolerances (unless otherwise specified):

- .XX ± 0.02 (0.5)
- .XXX ± 0.010 (0.25)
- Angles ± 1°

Components are shown for reference only and may vary between units.

50 Watt SBMQ48 Series 4:1 Encased DC/DC Converter



SHIPPING TRAYS AND BOXES, THROUGH-HOLE MOUNT

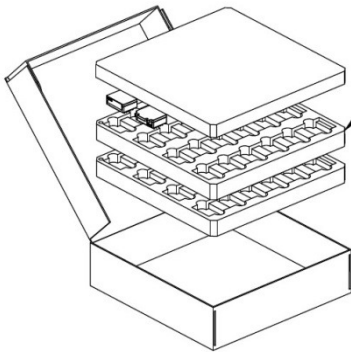

EACH STATIC DISSIPATIVE
POLYETHYLENE FOAM TRAY
ACCOMMODATES 24 CONVERTERS
IN A 4 X 6 ARRAY

24 UNITS PER TRAY
2 TRAYS PER CARTON
MPQ=48 UNITS

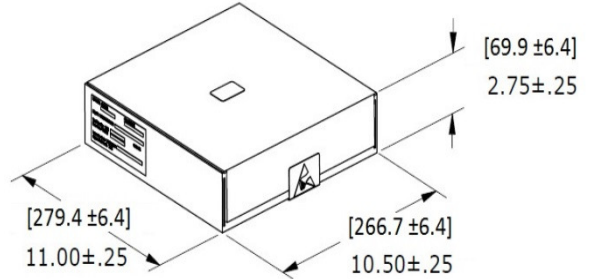

SHIPPING TRAY DIMENSIONS

Material: Low density, closed cell polyethylene anti-static foam

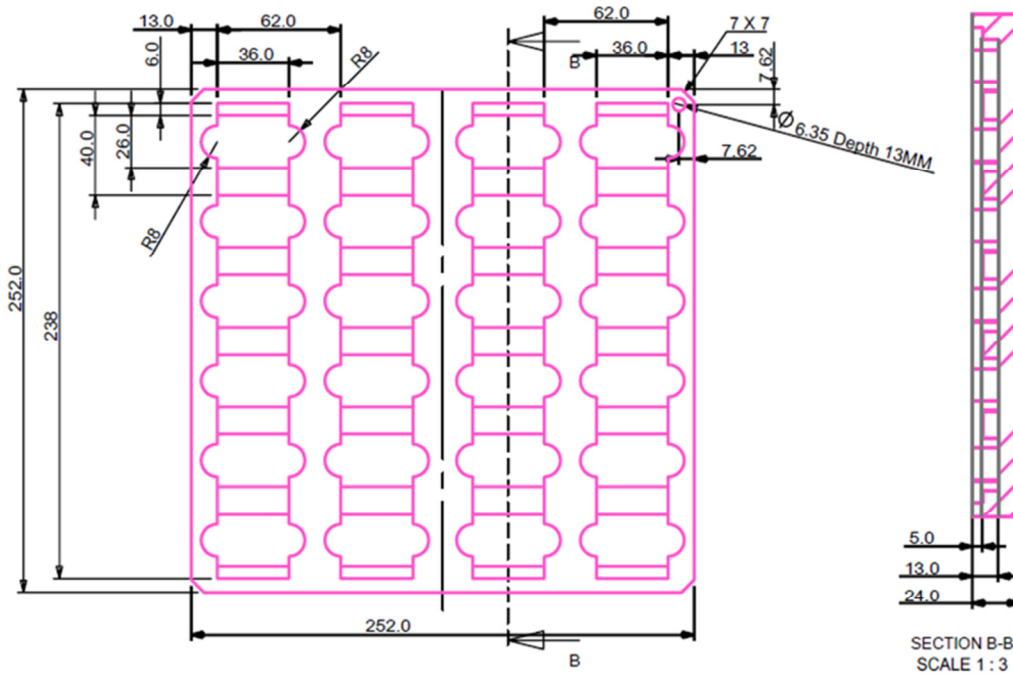

Dimensions are in millimeters.

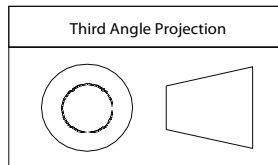

Tolerances (unless otherwise specified):

.XX ± 0.5

.XXX ± 0.25

Angles ± 2°

TECHNICAL NOTES

Input Fusing

Certain applications and/or safety agencies may require the installation of fuses at the inputs of power conversion components. Fuses should also be used if the possibility of sustained, non-current-limited, input-voltage polarity reversals exists. For SBM series DC-DC converters, we recommend the use of a fast blow fuse, installed in the ungrounded input supply line with a typical value about twice the maximum input current, calculated at low line with the converter's minimum efficiency.

All relevant national and international safety standards and regulations must be observed by the installer. For system safety agency approvals, the converters must be installed in compliance with the requirements of the end use safety standard, i.e. IEC/EN/UL60950-1.

Input Reverse-Polarity Protection

If the input voltage polarity is accidentally reversed, an internal diode will become forward biased and likely draw excessive current from the power source. If this source is not current limited or the circuit appropriately fused, it could cause permanent damage to the converter.

Input Under-Voltage Shutdown and Start-Up Threshold

Under normal start-up conditions, devices will not begin to regulate properly until the ramping-up input voltage exceeds the Start-Up Threshold Voltage. Once operating, devices will not turn off until the input voltage drops below the Under-Voltage Shutdown limit. Subsequent re-start will not occur until the input is brought back up to the Start-Up Threshold. This built in hysteresis prevents any unstable on/off situations from occurring at a single input voltage.

Start-Up Time

The V_{IN} to V_{OUT} Start-Up Time is the time interval between the point at which the ramping input voltage crosses the Start-Up Threshold and the fully loaded output voltage enters and remains within its specified accuracy band. Actual measured times will vary with input source impedance, external input capacitance, and the slew rate and final value of the input voltage as it appears at the converter. The SBM Series implements a soft start circuit to limit the duty cycle of its PWM controller at power up, thereby limiting the input inrush current.

The On/Off Control to V_{OUT} start-up time assumes the converter has its nominal input voltage applied but is turned off via the On/Off Control pin. The specification defines the interval between the point at which the converter is turned on (released) and the fully loaded output voltage enters and remains within its specified accuracy band. Similar to the V_{IN} to V_{OUT} start-up, the On/Off Control to V_{OUT} start-up time is also governed by the internal soft start circuitry and external load capacitance. The difference in start up time from V_{IN} to V_{OUT} and from On/Off Control to V_{OUT} is therefore insignificant.

Input Source Impedance

The input of SBM converters must be driven from a low ac-impedance source. The DC-DC's performance and stability can be compromised by the use of highly inductive source impedances. The input circuit shown in Figure 2 is a practical solution that can be used to minimize the effects of inductance in the input traces. For optimum performance, components should be mounted close to the DC-DC converter.

Transient and Surge Protection

The input range of the SBM Q48 modules cover EN50155 requirements for Brownout and Transient conditions with Nominal input voltages of 37.5V & 48Vdc.

EN50155 Standard			
Nominal Input	Permanent input range (0.7 - 1.25 V_{IN})	Brownout 100ms (0.6 x V_{IN})	Transient 1s (1.4 x V_{IN})
37.5V	26 - 47V	22.5V	52.5V
48V	33.6 - 60V	28.8V	67.2V

I/O Filtering, Input Ripple Current, and Output Noise

All models in the SBM Series are tested/specified for input reflected ripple current and output noise using the specified external input/output components/circuits and layout as shown in the following two figures. External input capacitors (C_{IN} in Figure 2) serve primarily as energy-storage elements, minimizing line voltage variations caused by transient IR drops in conductors from backplane to the DC-DC. Input caps should be selected for bulk capacitance (at appropriate frequencies), low ESR, and high rms-ripple-current ratings. The switching nature of DC-DC converters requires that dc voltage sources have low ac impedance as highly inductive source impedance can affect system sta-

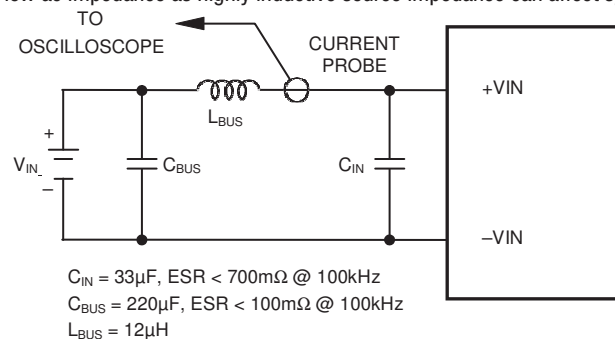

Figure 2. Measuring Input Ripple Current

bility. In Figure 2, C_{BUS} and L_{BUS} simulate a typical dc voltage bus. Your specific system configuration may necessitate additional considerations.

In critical applications, output ripple/noise (also referred to as periodic and random deviations or PARD) may be reduced below specified limits using filtering techniques, the simplest of which is the installation of additional external output capacitors. They function as true filter elements and should be selected for bulk capacitance, low ESR and appropriate frequency response.

All external capacitors should have appropriate voltage ratings and be located as close to the converter as possible. Temperature variations for all relevant parameters should also be taken carefully into consideration. The most effective combination of external I/O capacitors will be a function of line voltage and source impedance, as well as particular load and layout conditions.

50 Watt SBMQ48 Series 4:1 Encased DC/DC Converter

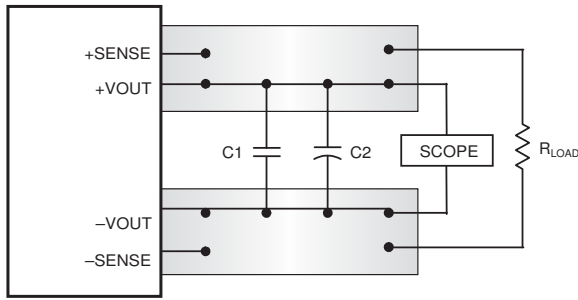

C1 = 1 μ F
C2 = 10 μ F
LOAD 2-3 INCHES (51-76mm) FROM MODULE

Figure 3. Measuring Output Ripple/Noise (PARD)

Floating Outputs

Since these are isolated DC-DC converters, their outputs are “floating” with respect to their input. Designers will normally use the –Output as the ground/return of the load circuit. You can however, use the +Output as ground/return to effectively reverse the output polarity.

Minimum Output Loading Requirements

SBM converters employ a synchronous-rectifier design topology and all models regulate within spec and are stable under no-load to full load conditions. Operation under no-load conditions however might slightly increase the output ripple and noise.

Thermal Shutdown

The SBM converters are equipped with thermal-shutdown circuitry. If environmental conditions cause the temperature of the DC-DC converter to rise above the designed operating temperature, a precision temperature sensor will power down the unit. When the internal temperature decreases below the threshold of the temperature sensor, the unit will self start. See Performance/Functional Specifications.

Output Over-Voltage Protection

The SBM output voltage is monitored for an over-voltage condition using a comparator. The signal is optically coupled to the primary side and if the output voltage rises to a level which could be damaging to the load, the sensing circuitry will power down the PWM controller causing the output voltage to decrease. Following a time-out period the PWM will restart, causing the output voltage to ramp to its appropriate value. If the fault condition persists, and the output voltage again climbs to excessive levels, the over-voltage circuitry will initiate another shutdown cycle. This on/off cycling is referred to as “hiccup” mode.

Short Circuit Condition

When a converter is in current-limit mode, the output voltage will drop as the output current demand increases. If the output voltage drops too low, the magnetically coupled voltage used to develop primary side voltages will also drop, thereby shutting down the PWM controller. Following a time-out period, the PWM will restart causing the output voltage to begin ramping to their appropriate value. If the short-circuit condition persists, another shutdown cycle will be initiated. This on/off cycling is referred to as “hiccup” mode. The hiccup cycling reduces the average output current, thereby preventing internal temperatures from rising to excessive levels. The SBM Series is capable of enduring an indefinite short circuit output condition.

Current Limiting

As soon as the output current increases to approximately 130% of its rated value, the DC-DC converter will go into a current-limiting mode. In this condition, the output voltage will decrease proportionately with increases in output current, thereby maintaining somewhat constant power dissipation. This is commonly referred to as power limiting. Current limit inception is defined as the point at which the full-power output voltage falls below the specified tolerance. See Performance/Functional Specifications. If the load current, being drawn from the converter, is significant enough, the unit will go into a short circuit condition as described below.

Remote Sense (Models 48QS5.50SBM only)

Note: The Sense and V_{OUT} lines are internally connected through low-value resistors. Nevertheless, if the sense function is not used for remote regulation the user should connect the +Sense to + V_{OUT} and –Sense to – V_{OUT} at the DC-DC converter pins. SBM series converters employ a sense feature to provide point of use regulation, thereby overcoming moderate IR drops in PCB conductors or cabling. The remote sense lines carry very little current and therefore require minimal cross-sectional-area conductors. The sense lines, which are capacitively coupled to their respective output lines, are used by the feedback control-loop to regulate the output. As such, they are not low impedance points and must be treated with care in layouts and cabling. Sense lines on a PCB should be run adjacent to dc signals, preferably ground.

$$[V_{OUT(+)} - V_{OUT(-)}] - [Sense(+)-Sense(-)] \leq 10\%V_{OUT}$$

In cables and discrete wiring applications, twisted pair or other techniques should be used. Output over-voltage protection is monitored at the output voltage pin, not the Sense pin. Therefore, excessive voltage differences between V_{OUT} and Sense in conjunction with trim adjustment of the output voltage can cause the over-voltage protection circuitry to activate (see Performance Specifications for over-voltage limits). Power derating is based on maximum output current and voltage at the converter’s output pins. Use of trim and sense functions can cause output voltages to increase, thereby increasing output power beyond the converter’s specified rating, or cause output voltages to climb into the output over-voltage region. Therefore, the designer must ensure:

$$(V_{OUT \text{ at pins}}) \times (I_{OUT}) \leq \text{rated output power}$$

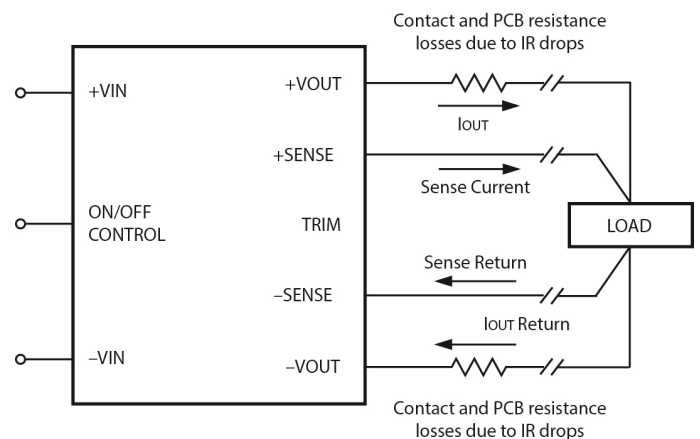

Figure 4. Remote Sense Circuit Configuration

NOTE: Sense is included only on Model 48QS5.50SBM.

50 Watt SBMQ48 Series 4:1 Encased DC/DC Converter



On/Off Control

The input-side, remote On/Off Control function can be ordered to operate with either logic type:

Positive ("Blank" suffix) logic models are enabled when the On/Off pin is left open or is pulled high (see specifications) with respect to the -Input as per Figure 4. Positive-logic devices are disabled when the on/off pin is pulled low with respect to the -Input.

Negative ("N" suffix) logic devices are off when the On/Off pin is left open or is pulled high (see specifications), and on when the pin is pulled low with respect to the -Input. See specifications.

Dynamic control of the remote on/off function is best accomplished with a mechanical relay or an open-collector/open-drain drive circuit (optically isolated if appropriate). The drive circuit should be able to sink appropriate current (see Performance Specifications) when activated and withstand appropriate voltage when deactivated. Applying an external voltage to pin 2 when no input power is applied to the converter can cause permanent damage to the converter.

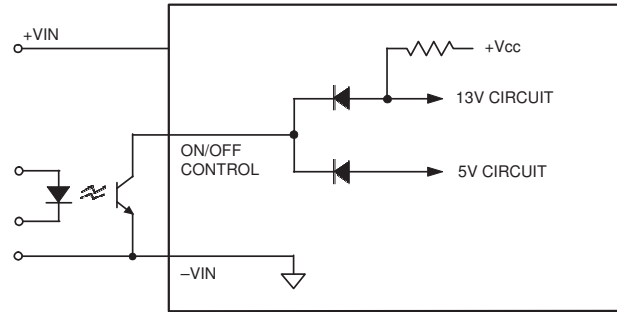

Figure 5. Driving the Negative Logic On/Off Control Pin (simplified circuit)

Trim Equations

Trim Down

$$R_{T \text{ DOWN}} (\text{k}\Omega) = \frac{511}{\Delta\%} - 10.22$$

$$\text{Where } \Delta\% = \left| \left(\frac{V_{\text{NOM}} - V_{\text{DES}}}{V_{\text{NOM}}} \times 100 \right) \right|$$

Trim Up

$$R_{T \text{ UP}} (\text{k}\Omega) = \frac{5.11 \times V_{\text{NOM}} \times (100 + \Delta\%)}{1.225 \times \Delta\%} - \frac{511}{\Delta\%} - 10.22$$

Note: "Δ%" is always a positive value.
"VNOM" is the nominal, rated output voltage.
"VDES" is the desired, changed output voltage.

OUTPUT VOLTAGE ADJUSTMENT

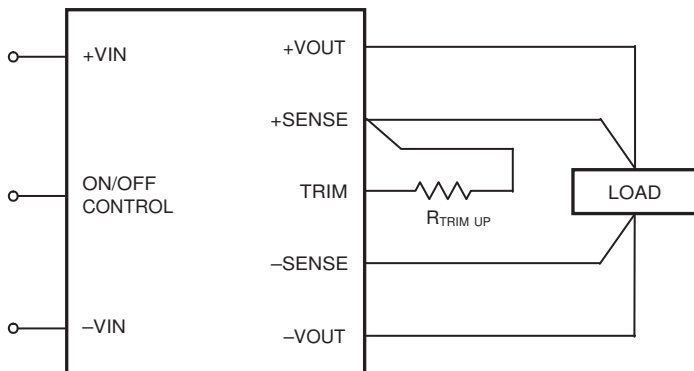

Figure 6. Trim Connections To Increase Output Voltages

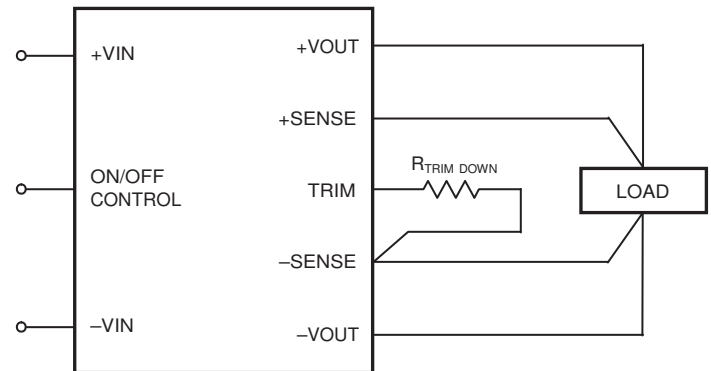

Figure 7. Trim Connections To Decrease Output Voltages

NOTE: Sense is included on the 48QS5.50SBM. Connect Trim to the respective Vout pin if sense is not installed.

50 Watt SBMQ48 Series 4:1 Encased DC/DC Converter



Through-Hole Soldering Guidelines

Calex recommends the TH soldering specifications below when installing these converters. These specifications vary depending on the solder type. Exceeding these specifications may cause damage to the product. Your production environment may differ; therefore please thoroughly review these guidelines with your process engineers.

Wave Solder Operations for through-hole mounted products (THMT)

For Sn/Ag/Cu based solders:

Maximum Preheat Temperature	115° C.
Maximum Pot Temperature	270° C.
Maximum Solder Dwell Time	7 seconds

For Sn/Pb based solders:

Maximum Preheat Temperature	105° C.
Maximum Pot Temperature	250° C.
Maximum Solder Dwell Time	6 seconds